

All sound systems need a power panel - why not have ONE TOUCH AC power control?
Motorized circuit breakers sequence sound system AC power!

MSP 341-xx Modular Sequencing Panelboard - The Electrician's choice



LynTec Modular Sequencing series panels add branch circuit sequencing to the main and branch circuit breaker functions normally found in a Load Center or Panelboard.

How they work
 Applies AC to low level, front-end electronics... waits for them to stabilize... (clicks and pops are ignored by un-powered power amplifiers)...
 AC is then sequenced to power amplifiers to spread high inrush currents over time.
 Protects valuable loudspeaker systems by delaying turn-on until all low level equipment has stabilized.

ONE TOUCH
 REMOTE POWER CONTROL

SHOWN ACTUAL SIZE



Green LED illuminated Red

SS-2 Sequencer Switch Set
 One SS-2 switch set is supplied with each panel.

LynTec
 Modular Sequencing series Power Panels

BENEFITS

- ✓ **ONE TOUCH remote power control**
 - Immediate visual feedback provided by flashing **ON** switch.
 - Light stays ON to verify sequence completion.
 - Process is reversed for turn-off sequence.
 - May be controlled from one to six locations.
 - Multiple sequencing panels may be daisy-chained for larger systems.
- ✓ **Reduced installation labor**
 - One wall-mounted, sequenced power panel feeds AC power to all rack and console receptacles.
- ✓ **Low power consumption**
 - **BMB** (Bolt-on) and **MB** (Clip-on) series motorized circuit breakers require no holding current (like DC relays) or heat sinks (like solid state relays).
 - Runs cool — lasts long.
- ✓ **Automatic load shedding and *BROWNOUT* protection**
 - A voltage sensing system automatically sheds the load when AC mains voltage drops below 95 volts for 2 seconds.
 - Capacitor-stored energy zips-off all circuits 2 seconds after power fails.
 - The system automatically re-sequences without operator intervention when stable voltage (above 105 volts for 5 seconds) resumes.
 - Reduces the start-up load for auxiliary power units.
 - Smart wake-up is ideal for unattended systems.
- ✓ **Kill**
 - Emergency instant shutdown may be triggered by an external contact closure.
 - System automatically re-sequences when contact opens.
- ✓ **HurryOff — *Ohh..... no..... switch* – Kill without restart**
 - By holding **any OFF** switch down for 2 seconds, the operator can trigger an instant shutdown with no automatic restart.

Planning and Layout Worksheet — As-built door label
LynTec MSLC 129-xx Modular Sequencing Load Center
 (One-Touch, sequential AC power control for Sound & AV Systems)

Breaker types, sizes, positions and connections

Job _____
 Panel _____
 Comments _____

 by _____ Date _____

M5-12 Sequencer circuit boards in left-hand, low voltage cabinet.

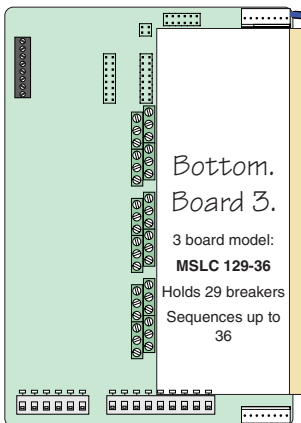
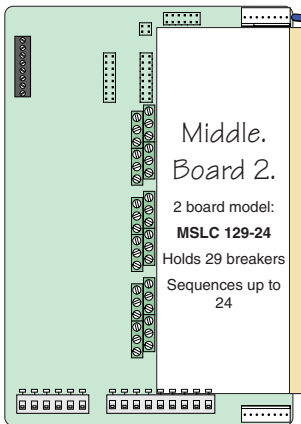
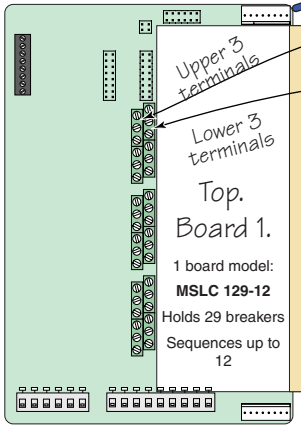

Each motorized breaker is controlled by a sequencer.
 As-built door label example:
 Step # **1a** (1a) (# in parenthesis is *suggested* breaker connection in sequencer).
 Bold line around box = *suggested* sequencer board: #1(Top), #2 or #3.
 Fill in box to indicate which sequencer board this breaker is connected to.

| | |
|---|---|
| 1 Amp. <input type="checkbox"/> Un-motorized. <input type="checkbox"/> Motorized-Step # ____ (1a) | 2 Amp. <input type="checkbox"/> Un-motorized. <input type="checkbox"/> Motorized-Step # ____ (1b) |
| 3 Amp. <input type="checkbox"/> Un-motorized. <input type="checkbox"/> Motorized-Step # ____ (2a) | 4 Amp. <input type="checkbox"/> Un-motorized. <input type="checkbox"/> Motorized-Step # ____ (2b) |
| 5 Amp. <input type="checkbox"/> Un-motorized. <input type="checkbox"/> Motorized-Step # ____ (3a) | 6 Amp. <input type="checkbox"/> Un-motorized. <input type="checkbox"/> Motorized-Step # ____ (3b) |
| 7 Amp. <input type="checkbox"/> Un-motorized. <input type="checkbox"/> Motorized-Step # ____ (4a) | 8 Amp. <input type="checkbox"/> Un-motorized. <input type="checkbox"/> Motorized-Step # ____ (4b) |
| 9 Amp. <input type="checkbox"/> Un-motorized. <input type="checkbox"/> Motorized-Step # ____ (5a) | 10 Amp. <input type="checkbox"/> Un-motorized. <input type="checkbox"/> Motorized-Step # ____ (5b) |
| 11 Amp. <input type="checkbox"/> Un-motorized. <input type="checkbox"/> Motorized-Step # ____ (6a) | 12 Amp. <input type="checkbox"/> Un-motorized. <input type="checkbox"/> Motorized-Step # ____ (6b) |
| 13 Amp. <input type="checkbox"/> Un-motorized. <input type="checkbox"/> Motorized-Step # ____ (1a) | 14 Amp. <input type="checkbox"/> Un-motorized. <input type="checkbox"/> Motorized-Step # ____ (1b) |
| 15 Amp. <input type="checkbox"/> Un-motorized. <input type="checkbox"/> Motorized-Step # ____ (2a) | 16 Amp. <input type="checkbox"/> Un-motorized. <input type="checkbox"/> Motorized-Step # ____ (2b) |
| 17 Amp. <input type="checkbox"/> Un-motorized. <input type="checkbox"/> Motorized-Step # ____ (3a) | 18 Amp. <input type="checkbox"/> Un-motorized. <input type="checkbox"/> Motorized-Step # ____ (3b) |
| 19 Amp. <input type="checkbox"/> Un-motorized. <input type="checkbox"/> Motorized-Step # ____ (4a) | 20 Amp. <input type="checkbox"/> Un-motorized. <input type="checkbox"/> Motorized-Step # ____ (4b) |
| 21 Amp. <input type="checkbox"/> Un-motorized. <input type="checkbox"/> Motorized-Step # ____ (5a) | 22 Amp. <input type="checkbox"/> Un-motorized. <input type="checkbox"/> Motorized-Step # ____ (5b) |
| 23 Amp. <input type="checkbox"/> Un-motorized. <input type="checkbox"/> Motorized-Step # ____ (6a) | 24 Amp. <input type="checkbox"/> Un-motorized. <input type="checkbox"/> Motorized-Step # ____ (6b) |
| 25 Amp. <input type="checkbox"/> Un-motorized. <input type="checkbox"/> Motorized-Step # ____ (1a) | 26 Amp. <input type="checkbox"/> Un-motorized. <input type="checkbox"/> Motorized-Step # ____ (1b) |
| 27 Amp. <input type="checkbox"/> Un-motorized. <input type="checkbox"/> Motorized-Step # ____ (2a) | 28 Amp. <input type="checkbox"/> Un-motorized. <input type="checkbox"/> Motorized-Step # ____ (2b) |
| 29 Amp. <input type="checkbox"/> Un-motorized. <input type="checkbox"/> Motorized-Step # ____ (3a) | SEQUENCER POWER 30 10A un-motorized breaker supplied installed. |

Transfer as-built information to the door label upon completion.

Keep this sheet for as-built documentation

Available as PDF download
www.lyntec.com/139-0258_MSLC129Plnr.pdf

LynTec MSLC 129-xx

-xx = Maximum number of sequenced breakers.
 See left side of page for model number explanation.

Cabinet Outline
 Surface mount only

Modular Sequencing Load Center

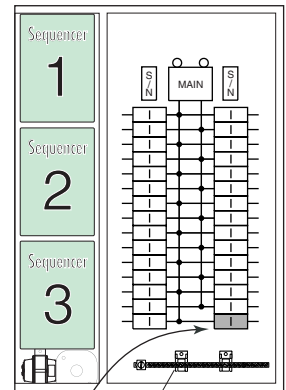

Isolated Technical Ground Bar
 Feed: 2/0 max.
 Branches: 26 positions, 4-14 ga.

Square D QO130M200 Load Center with LynTec low-voltage sidecar.

Standard Main Breaker: QOM2200VH.

200A, 22k AIR. [Amps Interrupt Rating]
 Main Breaker options — Part# suffix
 -M1125, -M1150, -M1175 Amp

Square D QOM2xxxVH, All 22k AIR.
 Wire: #4 - 350 kcmil Al/Cu.

Other back-fed main options

Uses positions 2 & 4 for back fed main breaker resulting in a **MSLC 127-xx-Mxxx** part #.

see www.lyntec.com/139-0274_MSLC127Plnr.pdf

MSLC 127 Main Options

Part# suffix — **Bold face**=Amps
 -M1030, -M1040, -M1060,
 -M1080 & -M1100 available.

Square D QO2xxxVH, all 22k AIR.
 Wire: #4 - 2/0 kcmil Cu.

Outside dimensions
 20.9" w., 29.8" h., 3.9" d.
 Surface mount only.

Low voltage control Wiring Diagram located inside left cover.

www.lyntec.com/139-0327_SequencerLV_Wiring.pdf

How it works

The **SEQUENCER POWER** breaker powers the sequencer circuit boards via a 24 volt transformer.

Motorized circuit breakers (marked **REMOTELY OPERATED**) are time sequenced by relays in the adjacent, left-side, low voltage sequencer cabinet.

The **ON** or **OFF** sequence is initiated at remote sound system locations and may be locally tested with the **top** green ON and **bottom** red OFF buttons on the circuit boards.

Sequenced breakers are sequenced on (Steps 1 to 6) and off (Steps 6 to 1) at 1/8 to 1 second intervals and may have a programmed **PAUSE DELAY** of up to 8 minutes during the sequence. These **STEP RATE, DELAY TIME** and **DELAY POSITION** settings are set by moveable jumpers inside the sequencer cabinet.

Each 6 step sequencer board controls up to 12 breakers by turning on and off two breakers per step.

The circuit boards are factory daisy-chained, top-to-bottom, with the **Cascade Connector (4 pin)** set.

The **Power & Kill Connector (4 pin)** set carries power, common and Kill signals.

ZIP-OFF load shedding

2 seconds after a power failure, the sequencer turns off all sequenced breakers. When power resumes the sequencer automatically re-sequences the system on.

ZIP-OFF may be demonstrated by turning off the **SEQUENCER POWER** breaker momentarily.

www.LynTec.com
800-724-4047
 8-5 Central Time
 146-0206-03 MSLC 129

Mechanical Dimensions and Knockouts

LynTec MSLC 113-xx, MSLC 127-xx or MSLC 129-xx Modular Sequencing Load Center

LynTec LCLC 326-xx or LCLC 329-xx (MLO) Lighting Control Load Center

LynTec MSLC 326-xx or MSLC 329-xx (MLO) Modular Sequencing Load Center

Surface Mount ONLY

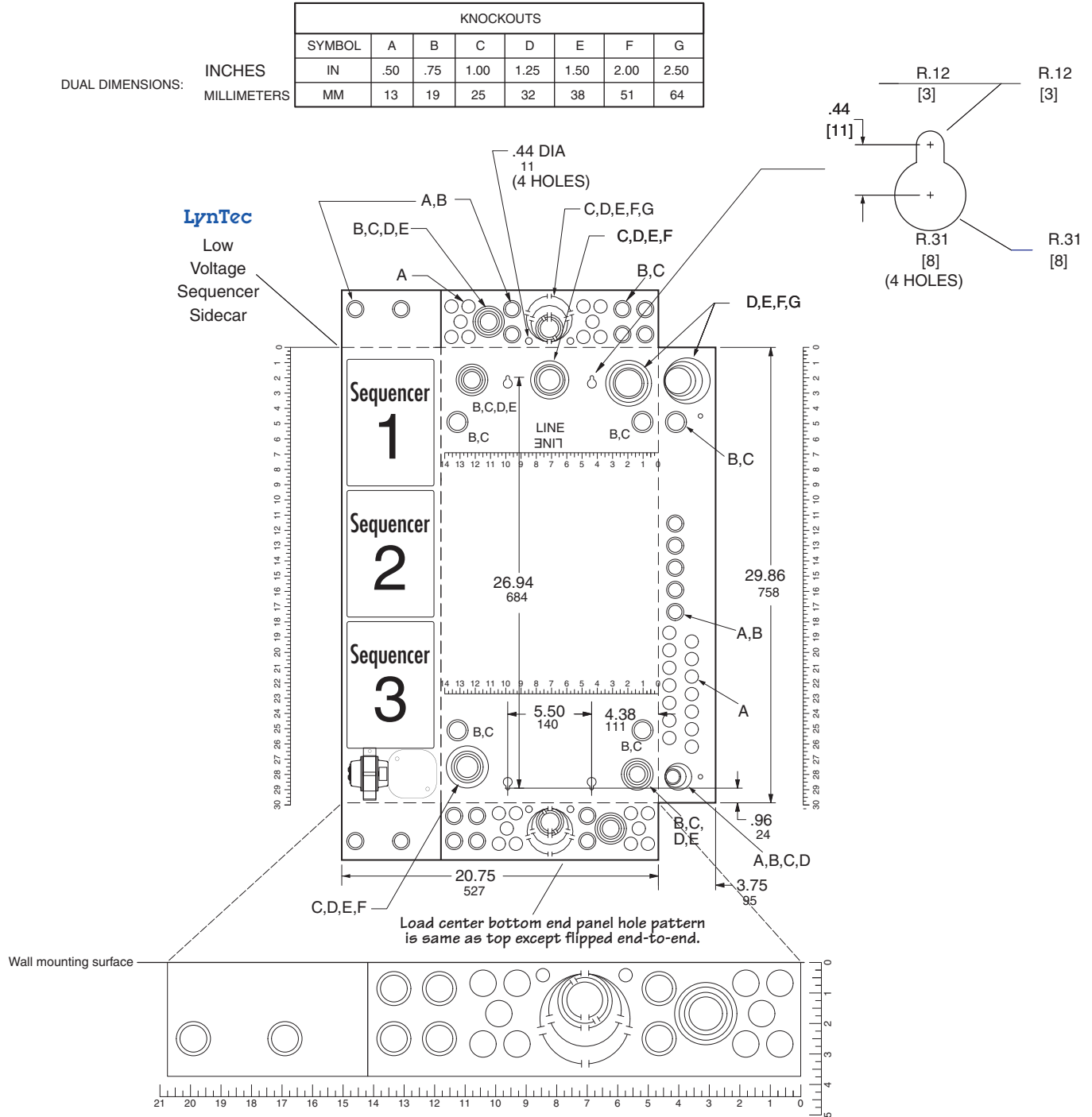

| KNOCKOUTS | | | | | | | |
|-----------|-----|-----|------|------|------|------|------|
| SYMBOL | A | B | C | D | E | F | G |
| IN | .50 | .75 | 1.00 | 1.25 | 1.50 | 2.00 | 2.50 |
| MM | 13 | 19 | 25 | 32 | 38 | 51 | 64 |

DUAL DIMENSIONS:
INCHES
MILLIMETERS

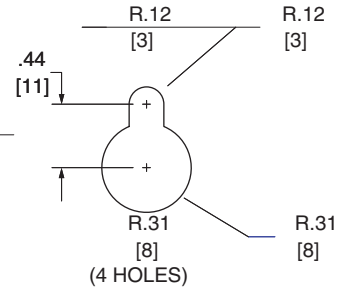

| LynTec | SQUARE D CATALOG NUMBER | MAXIMUM SYSTEM VOLTAGE | MAINS AMPERE RATING | SPACES | MAXIMUM NUMBER OF SINGLE POLE CIRCUITS | MAIN WIRE SIZE AWG AL/CU |
|--|-------------------------|------------------------|---------------------|--------|--|--------------------------|
| MSLC 113-xx, MSLC 127-xx or MSLC 129-xx | QO130M200 | 120/240Vac 1Ø, 3W | 200 | 30 | 30 | #4-250 |
| LCLC 326-xx, MSLC 326-xx or (MLO) LCLC 329-xx, MSLC 329-xx | QO327M100 | 208Y/120Vac 3Ø, 4W | 100 | 27 | 27 | #4-2/0 |



QDL & QGL
 2 and 3-pole
 70-250 Amperes

POWERPACT Q-frame ▲ —250 A, Thermal-magnetic (240 Vac)

| Current Rating @ 40°C | AC Magnetic Trip Settings | | D Interrupting | G Interrupting |
|------------------------|---------------------------|------|----------------|----------------|
| | Hold | Trip | Catalog Number | Catalog Number |
| 2-pole, 240 Vac | | | | |
| 70 | 1000 | 1800 | QDL22070 | QGL22070 ++ |
| 80 | 1000 | 1800 | QDL22080 | QGL22080 ++ |
| 90 | 1000 | 1800 | QDL22090 | QGL22090 ++ |
| 100 | 1200 | 2400 | QDL22100 | QGL22100 ++ |
| 110 | 1200 | 2400 | QDL22110 | QGL22110 ++ |
| 125 | 1200 | 2400 | QDL22125 | QGL22125 ++ |
| 150 | 1200 | 2400 | QDL22150 | QGL22150 ++ |
| 175 | 1200 | 2400 | QDL22175 | QGL22175 ++ |
| 200 | 1200 | 2400 | QDL22200 | QGL22200 ++ |
| 225 | 1200 | 2400 | QDL22225 | QGL22225 ++ |
| 250 | 1200 | 2400 | | |

LynTec MSP 139
 Use a 2 pole, back-fed main breaker, rated at 100 AMPS or less.
 QO2xxxVH Series
 22kAIR

LynTec MSP 119 MSP 141
 ++ All models 70-225A
 Special order. NCNR
 Non Cancelable
 Non Returnable

| Current Rating @ 40°C | AC Magnetic Trip Settings | | D Interrupting | G Interrupting |
|------------------------|---------------------------|------|----------------|----------------|
| | Hold | Trip | Catalog Number | Catalog Number |
| 3-pole, 240 Vac | | | | |
| 70 | 1000 | 1800 | | QGL32070 |
| 80 | 1000 | 1800 | | QGL32080 |
| 90 | 1000 | 1800 | | QGL32090 |
| 100 | 1200 | 2400 | | QGL32100 |
| 110 | 1200 | 2400 | | QGL32110 |
| 125 | 1200 | 2400 | | QGL32125 |
| 150 | 1200 | 2400 | QDL32150 + | QGL32150 |
| 175 | 1200 | 2400 | QDL32175 + | QGL32175 + |
| 200 | 1200 | 2400 | QDL32200 + | QGL32200 |
| 225 | 1200 | 2400 | QDL32225 ▶ | QGL32225 + |
| 250 | 1200 | 2400 | | |

LynTec LCLC 326 MSLC 326 MSLC 338 MSP 338
 Use a 3 pole, back-fed main breaker, rated at 100 AMPS or less.
 QO3xxxVH Series
 22kAIR

LynTec LCLC 341 MSLC 341
 ▶ Standard
 + Optional from stock
LynTec MSLCH 341
 + Optional from stock

▲ Replacement lugs are not available for POWERPACT Q-frame circuit breakers. Lugs for the POWERPACT Q-frame circuit breakers accept (1) #4-300 kcmil.

Interrupting Ratings (kA)

| | QD | QG |
|-------|----|----|
| 240 V | 25 | 65 |

For Branch Breaker Series Ratings
 see http://www.lyntec.com/139-0407_Series_Ratings.pdf

| | |
|---------------------|------------------|
| Accessories | pages 6-36-6-38 |
| Optional Lugs | pages 6-43, 6-44 |
| Dimensions | pages 6-49, 6-50 |
| Enclosures | pages 6-51-6-54 |

Series Ratings

For NQOD and NF Panelboards
Class 1630, 1670

This page contains UL Tested and Certified series combination ratings for panelboards. These ratings apply to either an integral main located in the same enclosure or a remote main located in a separate enclosure.

NQOD Series Ratings

| Maximum System Voltage AC ^c | Maximum Short Circuit Current Rating (RMS Symmetrical) | Integral or Remote Main Circuit Breakers and Remote Main Fuses | Branch Circuit Breaker Designations and Allowable Ampere Ranges ^{ab} | | | |
|---|--|--|---|-----------|-----------|--------------------------|
| | | | Type | 1-pole | 2-pole | 3-pole |
| 120/240 1Ø | 22k | MG | QO (B) | 15-30 A | ... | ... |
| | 42k | HD, JD | QO (B) PL | 15-30 A | 15-60 A | 15-30 A |
| | 65k | HG, JG | QO (B) PL | 15-30 A | 15-60 A | 15-30 A |
| | 100k | HJ, JJ | QO (B) PL | 15-30 A | 15-60 A | 15-30 A |
| | 125k | HL, JL | QO (B) PL | 15-30 A | 15-60 A | 15-30 A |
| 120/240 1Ø 208Y/120 | 100k | DJ 400 A | QO (B) | 15-70 A | 15-125 A | ... |
| | | | QO (B) GFI | 15-30 A | 40-60 A | ... |
| | 100k | QJ | QO (B) VH | ... | 150 A | 15-150 A |
| | | | QO (B) PL | 15-30 A | ... | ... |
| | | | QO (B) AF1 | 15-20 A | ... | ... |
| | | | QO (B) | 15-70 A | 15-125 A | 15-30 A |
| | | | QO (B) AS | 15-30 A | 15-30 A | 15-30 A |
| | | | QO (B) GFI | 15-30 A | 15-60 A | ... |
| | | | QO (B) PL | 15-30 A | 15-60 A | 15-30 A |
| | | | QO (B) VH | ... | 150 A | 35-150 A |
| QO (B) AF1 | 15-20 A | ... | ... | | | |
| 208Y/120 | 18k | LA/LH (L) 34200MC LA/LH (L) 34225MC LA/LH (L) 34250MC LA/LH (L) 34400MC | QO (B) | 15-30 A | 15-30 A | 15-30 A |
| | | | | | | |
| LynTec models LCLC 326 MSLC 326 MSP 338 MSP 139 | 22k | QO (B) VH | UMB-xx | 15-70 A | 15-125 A | 15-100 A |
| | | | MB-xx | 15-30 A | 15-60 A | 15-30 A |
| | | | QO (B) AS | 15-30 A | 15-60 A | ... |
| | | | QO (B) GFI | 15-30 A | 15-30 A | ... |
| | | | QO (B) PL | 15-30 A | 15-30 A | ... |
| | 22k | Q2-Hf | QO (B) | 15-70 A | 15-100 A | 15-30 A |
| | | | QO (B) GFI | 15-30 A | 15-30 A | ... |
| | | | QO (B) AF1 | 15-20 A | ... | ... |
| | | | QO (B) | 15-70 A | 15-125 A | 15-30 A |
| | | | QO (B) AS | 15-30 A | 15-60 A | ... |
| 25k | QD | UMB-xx | 15-70 A | 15-125 A | 15-30 A | |
| | | MB-xx | 15-30 A | 15-60 A | 15-30 A | |
| | | QO (B) GFI | 15-30 A | 15-60 A | ... | |
| | | QO (B) PL | 15-30 A | 15-60 A | 15-30 A | |
| | | QO (B) VH | ... | 150 A | 35-150 A | |
| LynTec models LCLC 341 MSLC 341 | 25k | ED, Fdf | QO (B) | 15-70 A | 15-125 A | 15-100 A |
| | | | QO (B) GFI | 15-30 A | 15-60 A | ... |
| | | | QO (B) AF1 | 15-20 A | ... | ... |
| | 25k | Kdf | QO (B) | 15-70 A | 15-125 A | 15-100 A |
| | | | QO (B) AS | 15-30 A | 15-60 A | 15-30 A |
| | | | QO (B) GFI | 15-30 A | 15-60 A | ... |
| | 25k | HD, JD | QO (B) | 15-70 A | 15-125 A | 15-100 A |
| | | | QO (B) VH | ... | 150 A | 35-150 A |
| | | | QO (B) GFI | 15-30 A | 15-60 A | ... |
| | | | QO (B) AF1 | 15-20 A | ... | ... |
| 42k | LA, MA | Q2L-Hf | ... | 110-225 A | 110-225 A | |
| | | QDL | ... | 70-225 A | 70-225 A | |
| 240 | 42k | LC 600 A Maximum | QO (B) | 15-70 Ad | ... | ... |
| | | | QO (B) VH | 15-30 A | 15-125 A | 15-100 A (3P 208 V Max.) |
| | 65k | QO (B) GFI | 15-30 Ae | 15-60 A | ... | ... |
| | | | QO (B) AF1 | 15-20 A | ... | ... |
| | 65k | DJ 400 A | QO (B) | 15-70 A | 15-125 A | 15-100 A |
| | | | QO (B) VH | ... | 150 A | 15-150 A |
| | 65k | EG, Fgf, KGf | QO (B) | 15-70 A | 15-125 A | 15-100 A |
| | | | QO (B) GFI | 15-30 A | 15-60 A | ... |
| | 65k | QG | QO (B) | 15-70 A | 15-125 A | 15-30 A |
| | | | QO (B) AS | 15-30 A | 15-30 A | 15-30 A |
| 65k | QO (B) VH | UMB-xx | 15-30 A | 15-60 A | 15-30 A | |
| | | MB-xx | 15-30 A | 15-60 A | 15-30 A | |
| 65k | HG, JG | QO (B) | 15-70 A | 15-125 A | 15-100 A | |
| | | QO (B) VH | ... | 150 A | 35-150 A | |
| 65k | FCL22 KCL22 FCL32 KCL32 | QO (B) | 15-70 A | 15-100 A | 15-100 A | |
| | | QO (B) AS | 15-30 A | 15-30 A | 15-30 A | |
| 65k | 400 A Max. Class J or T6 Fuses | QO (B) VH | 15-30 A | 15-125 A | 15-100 A | |
| | | QO (B) AF1 | 15-20 A | ... | ... | |
| 100k | FCL24 KCL24 FCL34 KCL34 | QO (B) | 15-70 A | 15-100 A | 15-100 A | |
| | | QO (B) AS | 15-30 A | 15-30 A | 15-30 A | |
| 100k | 200 A Max. Class T3 Fuses | QO (B) PL | 15-30 A | 15-30 A | ... | |
| | | QO (B) AF1 | 15-20 A | ... | ... | |
| 100k | EJ, FJf | QO (B) | 15-70 A | 15-125 A | 15-100 A | |
| | | QO (B) GFI | 15-30 A | 15-60 A | ... | |
| | | | QO (B) AF1 | 15-20 A | ... | ... |

LynTec models
LCLC 326
MSLC 326
MSP 338
MSP 139

LynTec models
LCLC 341
MSLC 341

LynTec models
MSLC 113
MSLC 127
MSLC 129
are series rated 22k AIR.
see QO130Mxx on pg 1-3 of Digest

8 PANELBOARDS

LynTec models
MSLCH 341
MSP 119
MSP 141

LCP 341
MSP 341

QOxxx (B) = BUMB series Bolt-on, UnMotorized Breaker
-xxx = poles. xxx = trip current.
[1 pole] BUMB-15, BUMB-20, BUMB-30
[2 pole] BUMB-215, BUMB-220, BUMB-230
[3 pole] BUMB-315, BUMB-320, BUMB-330

QOxxx = UMB series clip-on, UnMotorized Breaker
-xxx = poles. xxx = trip current.
[1 pole] UMB-15, UMB-20, UMB-30
[2 pole] UMB-215, UMB-220, UMB-230
[3 pole] UMB-315, UMB-320, UMB-330
All 15 & 20 A breakers are HM (High Magnetic)

NQOD Series Ratings (Continued)

| Maximum System Voltage AC ^c | Maximum Short Circuit Current Rating (RMS Symmetrical) | Integral or Remote Main Circuit Breakers and Remote Main Fuses | Branch Circuit Breaker Designations and Allowable Ampere Ranges ^{ab} | | | |
|--|--|--|---|----------|----------|----------|
| | | | Type | 1-pole | 2-pole | 3-pole |
| 240 | 100k | HJ, JJ | QO (B) | 15-70 A | 15-125 A | 15-100 A |
| | | | QO (B) VH | ... | ... | 35-150 A |
| | 125k | HL, JL | QO (B) GFI | 15-30 A | 15-60 A | ... |
| | | | QO (B) PL | 15-30 A | 15-60 A | 15-30 A |
| 200k | FI, KI | QO (B) GFI | 15-30 A | 15-60 A | ... | |
| | | QO (B) AF1 | 15-20 A | ... | ... | |
| 200k | Maximum Fuses 200 A Class J or T6 400 A Class T3 | QO (B) | 15-70 A | 15-125 A | 15-100 A | |
| | | QO (B) AS | 15-30 A | 15-30 A | 15-30 A | |
| | | | QO (B) GFI | 15-30 A | 15-60 A | ... |

- ▲ Suffixes HID, SWD and SWN may also be applied to the applicable branch circuit breakers shown above, except suffix SWN may NOT be applied in combination with LC main circuit breakers.
 - Where QO (B) circuit breakers are shown above, QO (B) H, QO (B) VH, and QH (B) circuit breakers may also be used.
 - ◆ For shown circuit breakers rated less than this maximum voltage, the indicated short circuit current rating also applies, but at the voltage rating of the circuit breaker.
 - ★ Only 15-30 A circuit breakers may be used when the LC circuit breaker is rated 450, 500 or 600 A.
 - ▼ Circuit breakers may not be used when the LC circuit breaker is rated 450, 500 or 600 A.
 - △ Obsolete. Contact your nearest Square D/Schneider Electric sales office for replacement circuit breaker. One-pole FJ circuit breakers are still available.
- Where QO(B) GFI circuit breakers are shown above, QO(B), EPD circuit breakers may also be used.

NF Series Ratings

| Maximum System Voltage AC | Maximum Short Circuit Current Rating (RMS Symmetrical) | Main Type | Branch Type | Poles | |
|---------------------------|--|--|---|------------------------|----------|
| 240 | 65,000 | EG, FH, FGF, KH, LH, MH, MX, HG, JG | EDB, EDB-EPD | 1, 2 & 3 | |
| | | EG | ECB-G3 | | |
| | 100,000 | EJ, FC, FJf, KC, LC, LX, HJ, JJ | EDB, EDB-EPD, EGB | 1, 2 & 3 | |
| | | EJ, FC, KC, HJ, JJ | ECB-G3 | | |
| | 125,000 | HL, JL | EDB, EDB-EPD, EGB, ECB-G3 | 1, 2 & 3 | |
| | | FI, KI, LI, LXI | ECB-G3 | | |
| | 200,000 | FI, KI | EDB, EDB-EPD, EGB, EJB | 1, 2 & 3 | |
| | | EG, FGF, KH, LH, HG, JG | ECB-G3 | | |
| | 480Y/277 | 35,000 | EG, HG, JG | EDB, EDB-EPD | 1, 2 & 3 |
| | | | EG, HG, JG | ECB-G3 | |
| 65,000 | | EJ, FC, FJf, KC, LC, LX, HJ, JJ | EDB, EDB-EPD, EGB | 1, 2 & 3 | |
| | | EJ, FC, KC, HJ, JJ | ECB-G3 | | |
| 100,000 | | HL, JL | EDB, EDB-EPD, EGB | 1, 2 & 3 | |
| | | FI, KI, LI, LXI | ECB-G3 | | |
| 200,000 | | FI, KI | EDB, EDB-EPD, EGB, EJB | 1, 2 & 3 | |
| | | FI, KI | ECB-G3 | | |
| 600Y/347 | | 18,000 | HG, JG, MG | EDB, EDB-EPD | 1, 2, 3 |
| | | | EJ, FI, KH, KL, LC, LE, LX, LI, LXI, HJ, JJ | EDB, EDB-EPD, EGB | |
| | 25,000 | LH | EDB(15-70 A), EGB | 1, 2, 3 | |
| | | LC, LE | EDB, EDB-EPD, EGB, EJB | | |
| | 35,000 | HL, JL | EDB, EDB-EPD, EGB | 1, 2, 3 | |
| | | FI, KI | EDB, EDB-EPD, EGB, EJB | | |
| | 65,000 | LI, XI | EJB | 1, 2 & 3 | |
| | | Remote Main Fuse | | | |
| | 240 | 200,000 | 200 Ampere Maximum Class J or T (600V) | ECB-G3 | 1, 2 & 3 |
| | | | 400 Ampere Maximum Class J or T (600V) | EDB, EDB-EPD, EGB, EJB | |
| 480Y/277 | 200,000 | 200 Ampere Maximum Class J or T (600V) | EDB, EDB-EPD, EGB, EJB | 1, 2 & 3 | |
| | | 200 Ampere Maximum Class J or T (600V) | ECB-G3 | | |
| 600Y/347 | 200,000 | 200 Ampere Maximum Class J or T (600V) | EDB, EDB-EPD, EGB, EJB | 1, 2 & 3 | |
| | | 200 Ampere Maximum Class J or T (600V) | ECB-G3 | | |

QOPLxxx-5393 = BMB series Bolt-on, Motorized. (REMOTELY OPERATED)
-xxx = poles. xxx = trip current. -5393 suffix denotes special 60" control wires.
[1 pole] BMB-15, BMB-20, BMB-30
[2 pole] BMB-215, BMB-220, BMB-230, BMB-240, BMB-250, BMB-260
[3 pole] BMB-315, BMB-320, BMB-330

QOPLxxx-5393 = MB series clip-on, Motorized. (REMOTELY OPERATED)
-xxx = poles. xxx = trip current. -5393 suffix denotes special 60" control wires.
[1 pole] MB-15, MB-20, MB-30
[2 pole] MB-215, MB-220, MB-230, MB-240, MB-250, MB-260
[3 pole] MB-315, MB-320, MB-330

Instruction Bulletin

QO-PL (Plug-on), QOB-PL (Bolt-on) Powerlink[®] Remotely Operated Circuit Breakers

(Use in Type QO Load Centers and Type NQO, NQOB, and NQOD Panelboards)

Retain for future use.

REQUIREMENTS

Remotely Operated Circuit Requirements

⚠ DANGER

HAZARD OF ELECTRIC SHOCK, BURN, OR EXPLOSION.

When servicing a branch circuit fed by a remotely operated circuit breaker, move handle of remotely operated circuit breaker to OFF position. Do not rely on remote operation to open circuit breaker.

Failure to follow these instructions will result in personal injury or death.

CIRCUIT BREAKER INSTALLATION

⚠ DANGER

HAZARD OF ELECTRIC SHOCK, EXPLOSION, OR ARC FLASH

- Apply appropriate personal protective equipment (PPE) and follow safe electrical work practices. See NFPA 70E.
- This equipment must be installed and serviced only by qualified electrical personnel.
- Turn off all power supplying this equipment before working on or inside equipment.
- Always use a properly rated voltage sensing device to confirm power is off.
- Replace all devices, doors, and covers before turning on power to this equipment.

Failure to follow these instructions will result in death, or serious injury.

See page 2 for
LynTec
part number explanation

POWERLINK[®] QO(B)-PL Remotely Operated Circuit Breakers require a power supply capable of delivering at least two amperes at 24 Vdc for a minimum of 50 milliseconds. One-, two-, and three-pole circuit breakers all have one internal motor, and power requirements are the same regardless of the number of poles and ampere ratings.

The required power supply ampacity and control device contact rating are determined by the number of circuit breakers to be switched simultaneously (i.e., four circuit breakers switched simultaneously require a power supply and a control device contact rated 8 amperes minimum). The control device may be either a normally-open (NO)/normally-closed (NC) contact; a single-pole, double-throw switch (SPDT); or other three-wire control device.

1. Turn off all power supplying this equipment before working on or inside equipment.
2. Before installing circuit breaker turn circuit breaker handle to OFF position.
3. Remove panelboard cover and deadfront. Verify power is off with voltage meter before proceeding.

Installation of circuit breaker into panelboard/load center (refer to figure below)

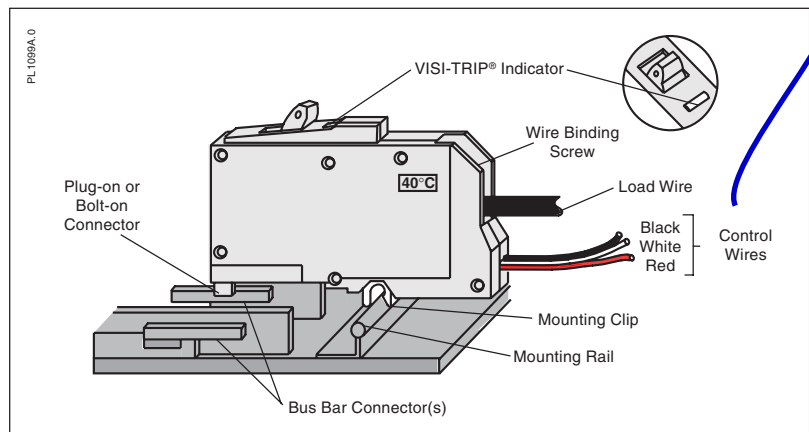

4. Except for remotely operated connections, QO(B)-PL remotely operated circuit breakers are installed in a panelboard/load center the same as conventional QO(B) circuit breakers.

Connection of remotely operated circuit (refer to the figure on next page)

5. Assure that power supply and control device meet requirements listed under "Remotely Operated Circuit Requirements."

All LynTec supplied breakers have special 60" control wires. (Square D standards are 18".)

CIRCUIT BREAKER INSTALLATION

CAUTION

HAZARD OF CIRCUIT BREAKER DAMAGE.

Connect the 24 Vdc remote control wiring as shown on this page.

Failure to follow these instructions can permanently damage the remotely operated circuit breaker.

LynTec
 part numbers

MB series motorized circuit breakers (Snap-On)
 May be used in LCLC, LCP, MSLC, MSP, SLC or SP series panels.

BMB series motorized circuit breakers (Bolt-On)
 Use only in LCP, MSP or SP Panelboards

All **BMB** & **MB** series breakers have Square D part number suffix of -5393 indicating a special 60 inch lead length for remote control wires required to connect to LynTec control boards in low voltage cabinet.

** = Stocked items

****MB-15** = 15 Amp. Square D QO-115PL-5393

****BMB-15** = 15 Amp. Square D QOB-115PL-5393

****MB-20** = 20 Amp. Square D QO-120PL-5393

****BMB-20** = 20 Amp. Square D QOB-120PL-5393

****MB-30** = 30 Amp. Square D QO-130PL-5393

****BMB-30** = 30 Amp. Square D QOB-130PL-5393

Two pole motorized - call for pricing & delivery

MB-215 = 15 Amp. Square D QO-215PL-5393

BMB-215 = 15 Amp. Square D QOB-215PL-5393

****MB-220** = 20 Amp. Square D QO-220PL-5393

****BMB-220** = 20 Amp. Square D QOB-220PL-5393

MB-230 = 30 Amp. Square D QO-230PL-5393

BMB-230 = 30 Amp. Square D QOB-230PL-5393

40A, 50A or 60A, Two pole also available on Special Order

Three pole motorized - call for pricing & delivery

MB-315 = 15 Amp. Square D QO-315PL-5393

BMB-315 = 15 Amp. Square D QOB-315PL-5393

MB-320 = 20 Amp. Square D QO-320PL-5393

BMB-320 = 20 Amp. Square D QOB-320PL-5393

MB-330 = 30 Amp. Square D QO-330PL-5393

BMB-330 = 30 Amp. Square D QOB-330PL-5393

LynTec also stocks **UMB** & **BUMB** (un-motorized) QO series circuit breakers including HM (High Magnetic). Recommended for eliminating nuisance trips in high inrush applications. [All BMB & MB-x15's and BMB & MB-x20's are HM breakers.]

800-724-4047

LynTec ■ www.LynTec.com

8401 Melrose Dr., Lenexa, KS 66214, USA

Voice 913-529-2233 • Fax 888-722-4157 or 913-529-4157

LynTec overprint 139-0216-08.2 9/23/06

- All wiring and splicing must comply with applicable code requirements for Class 1 circuits. Refer to paragraph 373-8 and article 725 of the National Electrical Code.
- Three #18 AWG control wires are attached to the remotely operated circuit breaker for connection to the power supply and remote control device and should be cut to the required length to reach the splice connections. Use #18 AWG or larger conductors with 600 V insulation and approved wire connectors for splices.
- Connect the black lead of the remotely operated circuit breaker to the negative (-) terminal of the 24 Vdc power supply. Connect the red lead of the remotely operated circuit breaker to the positive (+) terminal of the 24 Vdc power supply. Connect the white lead of the remote control device. The remote control device provides connections between either positive or negative potential of the power supply and the white wire of the remotely operated circuit breaker, as appropriate.
- Applying the positive potential of the power supply to the white wire (contact closure between the red wire and white wire) will operate the remote mechanism of the circuit breaker to the OFF position. Applying the negative potential of the power supply to the white wire (contact closure between the black wire and the white wire) will operate the remote mechanism of the circuit breaker to the ON position. A control circuit utilizing a normally open (NO)/normally closed (NC) contact is illustrated below.

NOTE: The remote mechanism will not move the circuit breaker handle. Also, the remote mechanism cannot turn power ON when the circuit breaker is tripped (VISI-TRIP® flag indicator showing) or when the circuit breaker handle is in the OFF position.

Installation of the trim and operational checks

- Remove corresponding twist-out from panelboard trim and replace trim.
- Turn power to panelboard on.
- Turn remotely operated circuit breaker handle to the ON position.
- Turn power to the remotely operated circuit on and test this circuit, turning remotely operated circuit breaker off remotely, then on remotely. If power to remote controlled circuit breaker load does not switch off and on, turn off power to remotely operated circuit and panelboard and check wiring.

NOTE: A power supply is available from Square D Company, Cat. No. QOPLPS (plug-on) or QOBPLPS (bolt-on).

Splice not normally required with LynTec supplied breakers with 60" leads.

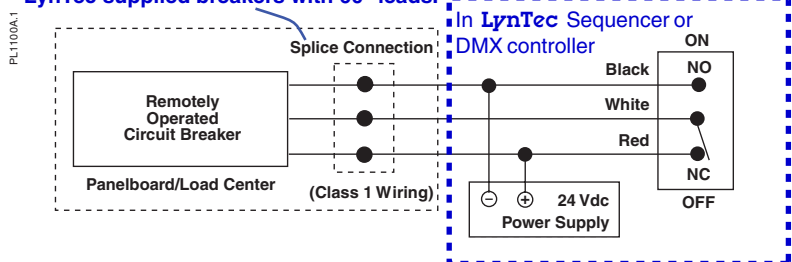

Square D Company
 3700 Sixth Street SW
 Cedar Rapids IA 52404 USA
 1-888-SquareD (1-888-778-2733)
 www.SquareD.com

Electrical equipment should be installed, operated, serviced and maintained only by qualified personnel. No responsibility is assumed by Schneider Electric for any consequences arising out of the use of this material.

© 1991-2003 Schneider Electric All Rights Reserved



A.C. Sequencing Systems

Wire requirements

Switch set to sequencer: 4 conductors.
 Between daisy chained sequencers:
 9 conductors, 11 if Power Vouchers are used.
 Up to 2500 ft. run: 24 ga.
 2,500 to 3,750 ft. run: 22 ga.

To **LynTec**
PDS, MRTS, MSLC,
SLC, MSP or SP
 series sequencer

Rear view wiring diagram

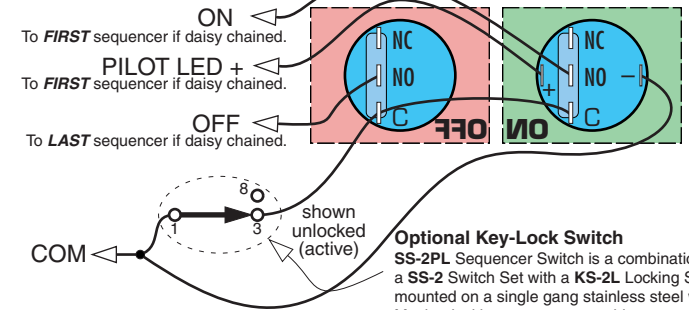

Optional Key-Lock Switch
SS-2PL Sequencer Switch is a combination of a **SS-2** Switch Set with a **KS-2L** Locking Switch, mounted on a single gang stainless steel wall plate. Mechanical layout on reverse side.

See reverse side for multiple switch set wiring.

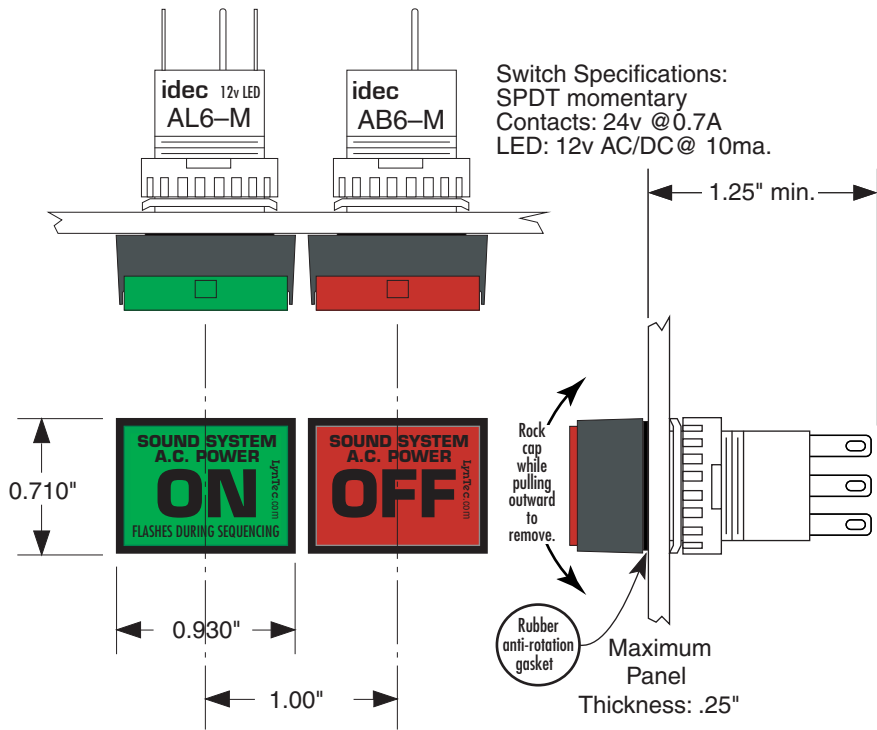

Switch Specifications:
 SPDT momentary
 Contacts: 24v @0.7A
 LED: 12v AC/DC @ 10ma.

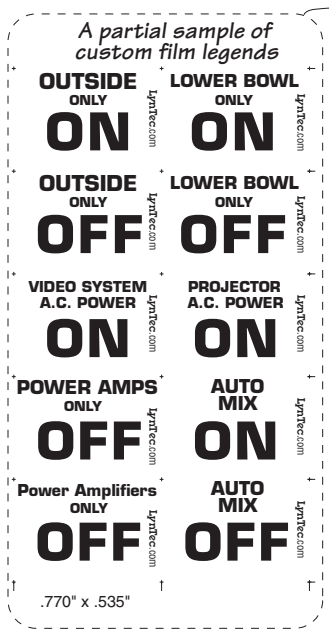

Actual size drill templates

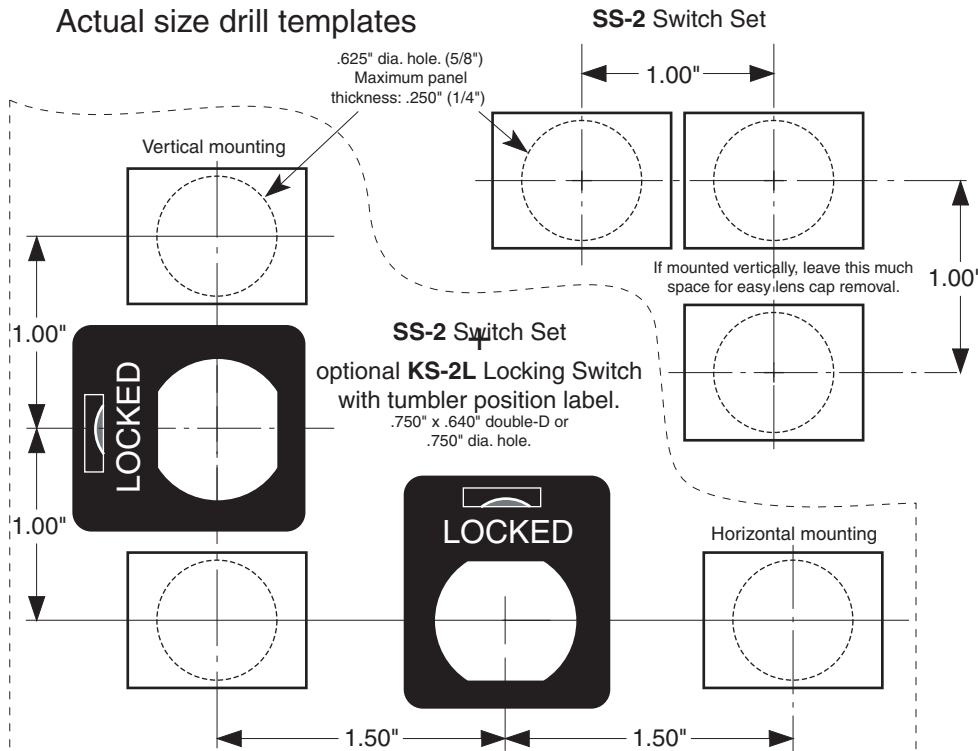

SS-2 Switch Set

SS-2 Switch Set
 optional **KS-2L** Locking Switch
 with tumbler position label.
 .750" x .640" double-D or
 .750" dia. hole.

LynTec

one

SS-2 Sequencer Switch Set

Up to 5* additional remote control locations may be added to the system with additional switch sets or with other momentary switches.

Multiple Sequencer Hookup Diagram

For **LynTec MSLC** and **MSP MODULAR** and **PDS-8EK** Power Sequencing Products

Custom switch legends you can print on your laserprinter

Showing Low-Voltage Remote **ON/OFF** Control and Daisy-Chain Wiring

See http://www.lyntec.com/139-0309_CSLF-1_Film.pdf

One set of the **ON** and **OFF** switches shown below are supplied unmounted as a **SS-2** Switch Set with each LynTec sequencer cabinet. Mount in 5/8" dia. round holes in panels up to 1/4" thick.



LynTec Model SS-2PL
Locking Switch Set.
(Optional)

Switch layout for field constructed panel mounting.
1/4" max. panel thickness.

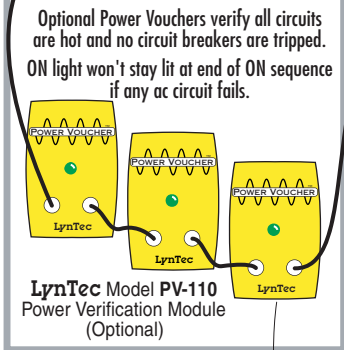
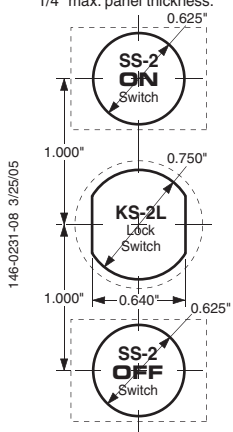

LynTec Model PV-110
Power Verification Module
(Optional)

★ Parallel connect additional SS-2 switch sets for multiple remote control locations.
4 conductors, 24 ga., 5,000 ft. loop max.

Maximum number of switch sets:

All LynTec sequencers support 6 switch sets.

LynTec

Lenexa, KS (Central time zone) U.S.A.
Voice **800-724-4047** or 913-529-2233
Fax **888-722-4157** or 913-529-4157
www.LynTec.com

For **single** sequencer board hookup connect OFF switch normally open to OFF.

PILOT LED (green)

Cage clamp terminal blocks. Press white levers back with small straight-blade screwdriver to insert stripped wires.

These expansion terminals on the top or middle boards are NOT used when the cascade connectors are used to daisy-chain boards within a cabinet.

FIRST
Sequencer Board (Top)

NOT in PDS-8EK
See daisy-chain connections below for wiring between PDS-8s or multiple cabinets.

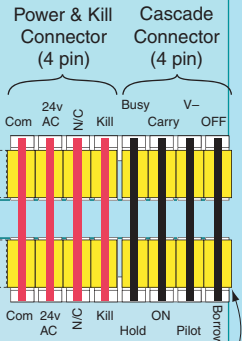

+5v CMOS Logic output. Mimics Pilot LED. 3.3KΩ source impedance. (For touch panel drive)

When sequencers are daisy-chained **avoid** using these test switches. Use the **first ON** test switch and the **last OFF** test switch to avoid confusing operation.

For multiple control points add SS-2's or SS-2PL's. Parallel connect lines.

To run each sequencer board as a separate system, remove the **right** Cascade Connector. Connect ON, Pilot, Com & OFF to switch set.

To isolate the **Hurry-Off** and **Kill** functions, unplug **left** Power & Kill Connector and move to the left one step, mis-mating to eliminate the board-to-board Kill connection.

LAST
Sequencer Board (Bottom)

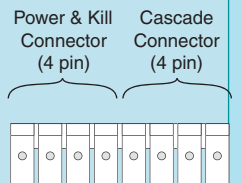

These expansion terminals on the **bottom** board are only used for daisy-chain connections when more than one cabinet is used.

Kill — Fire alarm shutdown

External contact closure lights the red Kill LEDs and kills all sequenced power.

Contact opening restarts the ON sequence.

See next page for enlarged daisy-chain hookup
Low voltage control wire: 24 gauge minimum, 5,000 ft. loop max.

A typical three panel, daisy-chained, system with two locking control locations.

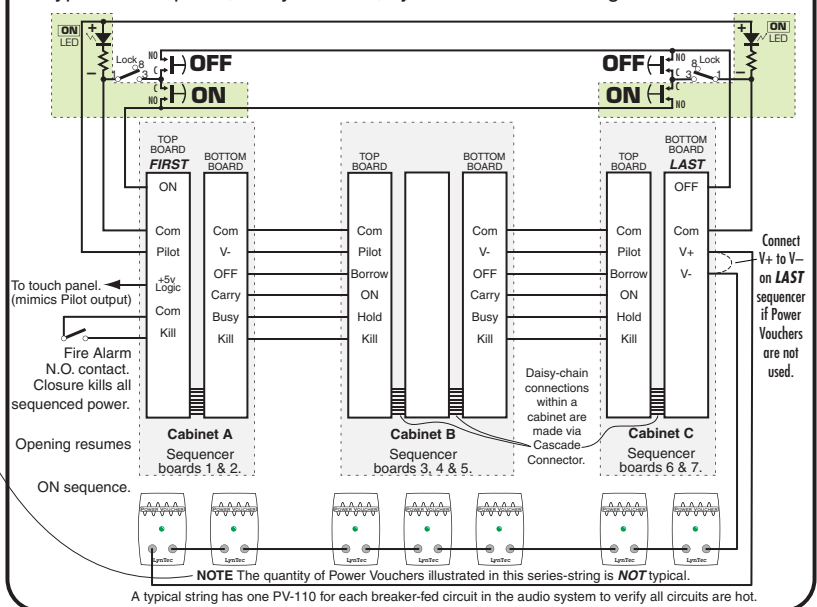

NOTE The quantity of Power Vouchers illustrated in this series-string is **NOT** typical. A typical string has one PV-110 for each breaker-fed circuit in the audio system to verify all circuits are hot.

A typical LynTec three panel, daisy-chained system with two locking control locations.

For Timing Diagram and Logic levels
See http://www.lyntec.com/139-0266_Seq_Timing.pdf

Wire Requirements for Remote Controls

- Basic system ON/OFF Control from one panel only4 conductors
- Basic + Kill Add Kill function6 conductors
- 2 conductors to Kill control location
- Remote control at both ends9 conductors
- Kill, Remote control both ends, full power verification11 conductors
- Low voltage control wire: 24 gauge minimum, 5,000 ft. loop max.

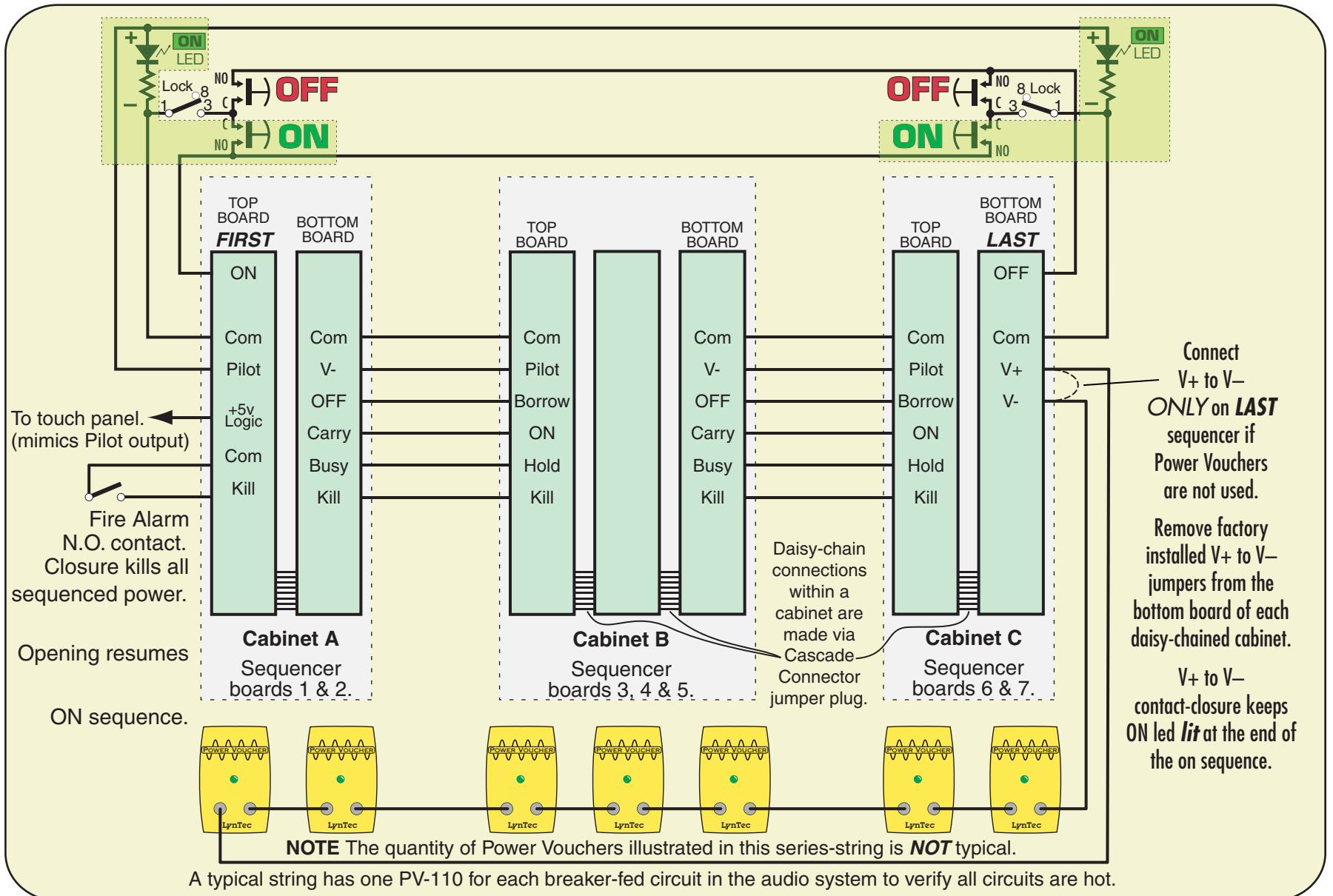

Built-in Kill, Hurry-Off and **ZipOff** (PANIC) switch option for **MSLC** and **MSP** and **PDS-8EK** series AC SEQUENCING SYSTEMS

What the functions do

Kill — EMERGENCY SHUTDOWN

Provides an *IMMEDIATE* shut down method for the sound system at the command of a fire alarm, emergency announcement system, or ZipOff switch.

Optional **ZipOff** switch, **ZOS-5K**

Provides a full AC Power shutdown within 250 milliseconds after the **ZipOff** button is pushed.

In case of a runaway oscillation or other unexpected signal which could damage the loudspeakers if sustained...

Lift the protective cover and press the ZipOff button... it latches down and lights red. The AC power sequencing system immediately zips off.

Press again to unlatch... the light goes out and the sequencer restarts to repower the system.

OR

Use the new **Hurry-Off** function at any OFF switch.

MULTI-BOARD SHUNT R

The Kill line is an 11 ma. current source from each MS-12 Modular Sequencer or PDS-8 EK board

A voltage sensor on the Kill line determines the Kill threshold.

The Kill line has an open circuit voltage of 28 volts which must be pulled down to less than 10.5 volts to generate a Kill function. Grounding the Kill line to Common will always kill the system instantly. This current source may also be used to light the Zip-Off switch's, red LED.

The red ZipOff LED only requires 10 ma. For systems where multiple-board system's Kill lines are paralleled, a 9 v. voltage regulator chip is installed in the **ZOS-5K** which will automatically shunt the excess source current of up to 5 boards. For more than 5 boards an additional resistor must be used in parallel with the ZipOff switch LED. To prevent damage due to overheating the voltage regulator chip, the resistor should be installed as shown with **full length leads** to get the heat source away from the switch.

| Total Number of boards | Shunt Resistor required | | |
|------------------------|-------------------------|----------|---------|
| 1-5 | none | | |
| 6 | 820Ω, 1/4w | 16 | 75Ω, 2w |
| 7 | 430Ω, 1/4w | 17 | 68Ω, 2w |
| 8 | 270Ω, 1/2w | 18 | 62Ω, 2w |
| 9 | 200Ω, 1/2w | 19 | 56Ω, 2w |
| 10 | 150Ω, 1/2w | 20 | 56Ω, 2w |
| 11 | 150Ω, 1w | 21 | 51Ω, 2w |
| 12 | 120Ω, 1w | 22 | 47Ω, 2w |
| 13 | 100Ω, 1w | 23 | 47Ω, 2w |
| 14 | 92Ω, 1w | 24 | 43Ω, 2w |
| 15 | 82Ω, 1w | 25 | 39Ω, 2w |

What to specify or order

For **ZipOff** switch order **ZOS-5K**. (services up to 5 Kill equipped boards)

Includes switch with ZipOff film legend and flip up security cover.

Switch mounts in 5/8" round hole in panels up to 3/16" thick.

ZOS-5K Contractor C.O.D. price: \$40.

Delivery: Stock.

Hurry-Off

The MS-12 Modular & PDS-8EK Sequencing boards have a new Hurry-Off function. If you **hold down** any OFF switch for two seconds, a "Kill without restore" function is triggered. The system shuts down within 250 milliseconds and doesn't restart until you give it a new ON command. Kinda like a DSP undo command.

How they work

All LynTec sequencing systems have the ZipOff load shedding feature. The older SLC, SP and PDS-8's implemented it by interrupting 24v ac power.

The newer Modular sequencers, the MSLC and MSP series and the PDS-8EK, load shed when power fails, but also have a **Kill** function that is triggered by grounding the **Kill** line.

The red **Kill** LED, adjacent to the Kill terminal on the board, lights and Zip-Off is immediate. The kill line is a low current line. Long control wiring may be used without concern for loop resistances up to 32Ω. (22 gauge, up to a 1,000 ft. run [2,000 ft. loop] or a 680 ft. run of 24 ga).

The ON/OFF *latching* pilot relay remembers that the sequencer was ON. When the **Kill** line is opened, the ON sequence repeats, bringing the AC power back on.

For the Modular series control boards the **ZipOff** switch connects the Kill line to common, through the Zip-Off switch's LED, initiating the Kill function.

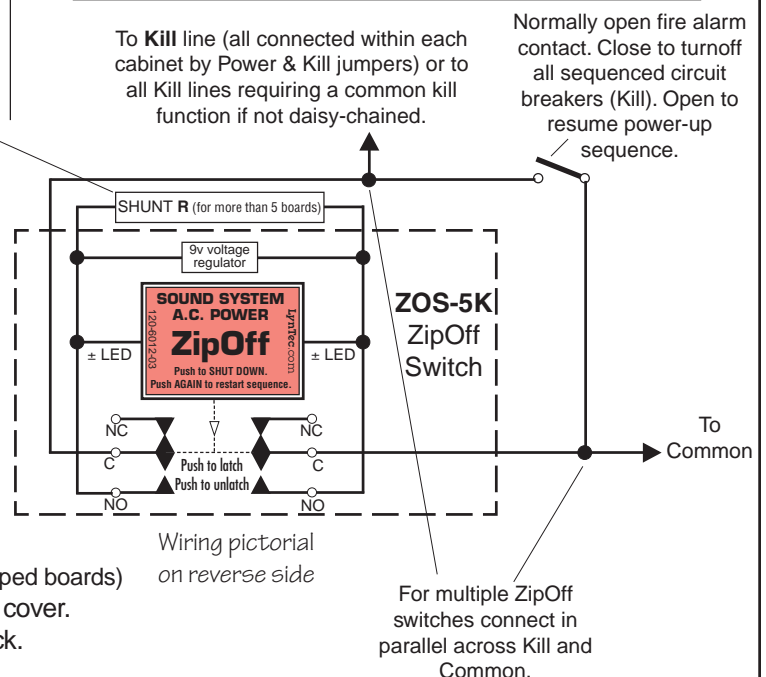

www.**LynTec**.com

8401 Melrose Drive • Lenexa, KS 66214 • Voice **800-724-4047** or 913-529-2233 • Fax **888-722-4157** or 913-529-4157

for **Modular A.C. Sequencing Systems**, models **MSLC, MSP & PDS-8EK.**

ON, OFF and ZipOff switch mounting & wiring

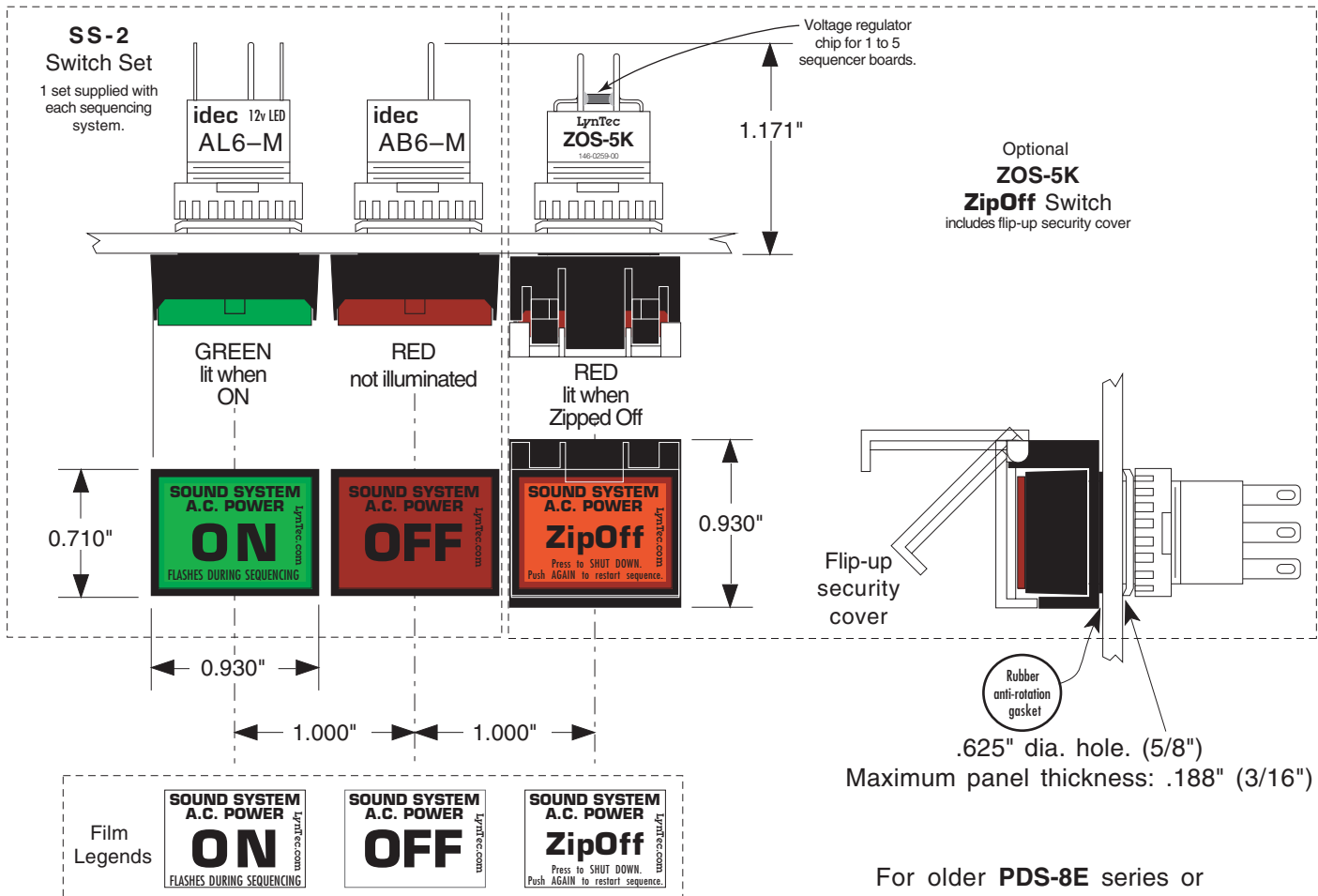

For older **PDS-8E** series or **SLC, SP** series sequencers see

http://www.lyntec.com/139-0137_ZOS-1.pdf

Wiring pictorial - Rear view

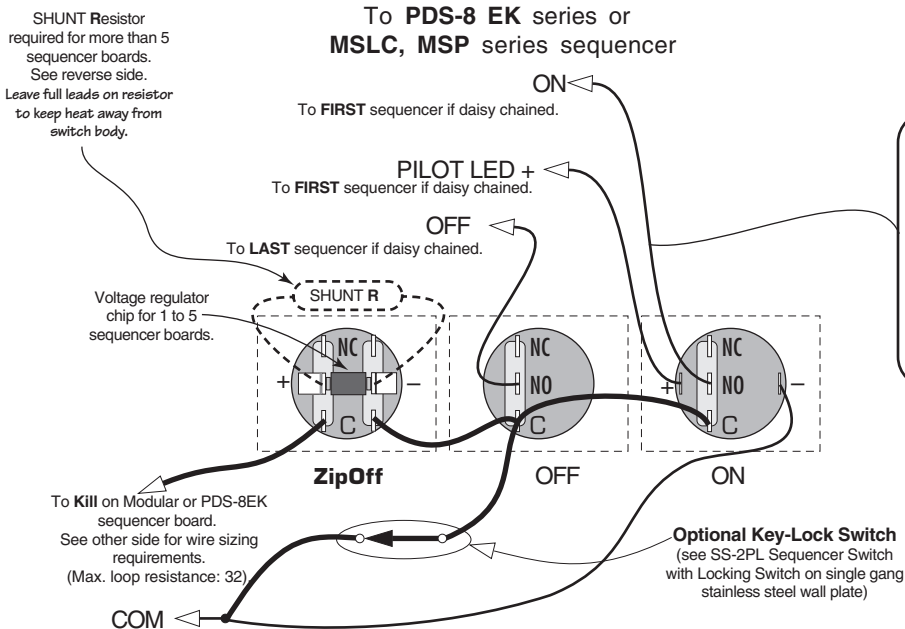

Wire requirements

Switch set to sequencer: 4 conductors.
Between daisy chained Modular sequencers: 9 conductors, 11 if Power Vouchers are used.
Up to 5,000 ft run: 22 ga.,
5,000 to 7500 ft. run: 20 ga.
7,500 to 10,000 ft. run: 18 ga.
See other side for **ZipOff** wire sizing.