

# LynTec RS-232 Controlled Panels and Load Centers

## Motorized Breakers Make Control Easy!

All relay based systems **MUST** be electrically protected by a circuit breaker. Motorized breakers eliminate the need for wall or rack mounted relay based systems...

- ❑ Saves Space
- ❑ Saves redundant installation and hardware costs!
- ❑ UL listed circuit breaker with built-in internal switching capability manufactured by 
- ❑ Time tested, in service over 20 years
- ❑ Available in 15A, 20A and 30A - 1, 2 or 3 poles for remote control of all electrical loads
- ❑ Robust - rated for 60k on, off, on cycles
- ❑ Energy efficient - NO holding current or heat sinks required to maintain state - Runs cool, lasts long!
- ❑ Automatic load shedding and brownout protection in every panel.
- ❑ Emergency override function standard on every panel.



## Specifying in 5 easy steps

1. Choose the control method: **SC**=RS-232
2. Choose the cabinet style: **LC** for load center and **P** for panelboard
3. Choose three phase (**3**) or single phase (**1**)
4. Choose the number of circuits: **26** or **41** Panelboards are only available in 41 circuits.
5. Choose the maximum number of controlled circuits: **10, 20, 30, 40, or 50.**

EX: **SCLC 326-20** = a 3 phase load center with 26 circuits (24 max controlled)

**SCP 341-30** = a 3 phase panel board with 41 circuits (30 max controlled)

**All panels and load centers**

# Planning and Layout Worksheet — As-built door label

## LynTec SCLC 326-xx RS-232 Controlled Load Center

RS-232 controlled, AC power remote control for un-dimmed lighting circuits

### Breaker types, sizes, positions and connections

Job \_\_\_\_\_

Panel \_\_\_\_\_

Comments \_\_\_\_\_

by \_\_\_\_\_ Date \_\_\_\_\_

Transfer as-built information to the door.

Keep this sheet for as-built documentation.

Available as PDF download  
[www.lyntec.com/139-0537\\_SCLC-326\\_Plnr.pdf](http://www.lyntec.com/139-0537_SCLC-326_Plnr.pdf)

**LynTec**  
**RS-232 Controlled Load Center**  
**SCLC 326-xx**  
 -xx = Maximum number of controlled breakers.  
 See right side of page for model number for explanation.

Cabinet Outline — Surface mount only

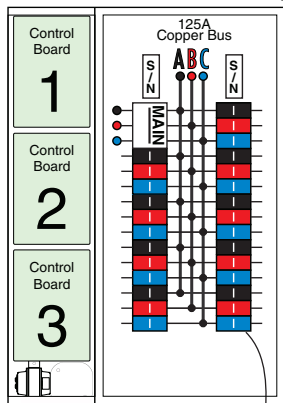

Each motorized breaker is actuated by a command from a RS-232 control device by \_\_\_\_\_  
 As-built door label example:  
 The RS-232 # \_\_\_\_\_ is the RS-232 address of this breaker.  
 The board jumpers set the RS-232 address of the board. Each breaker has a sub-address of 1-10  
 Bold line around box  = **suggested** control board: #1 (Top), #2, #3 or #4.  
 Fill in  box to indicate which control board this breaker is connected to.

5C-10 circuit boards in left-hand, low-voltage cabinet.

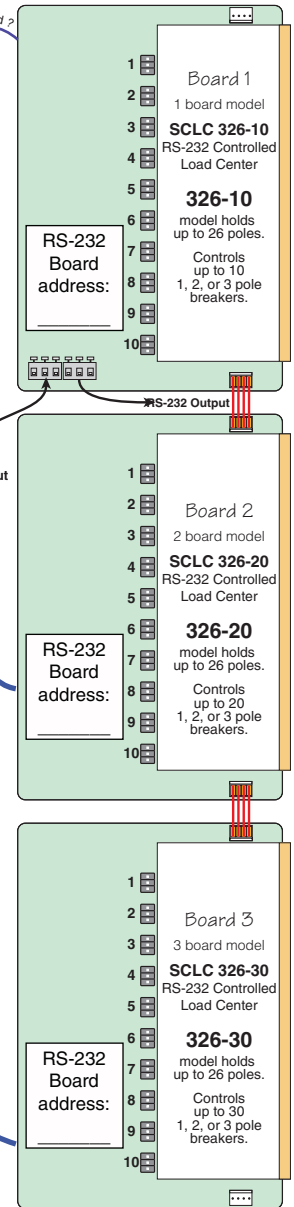
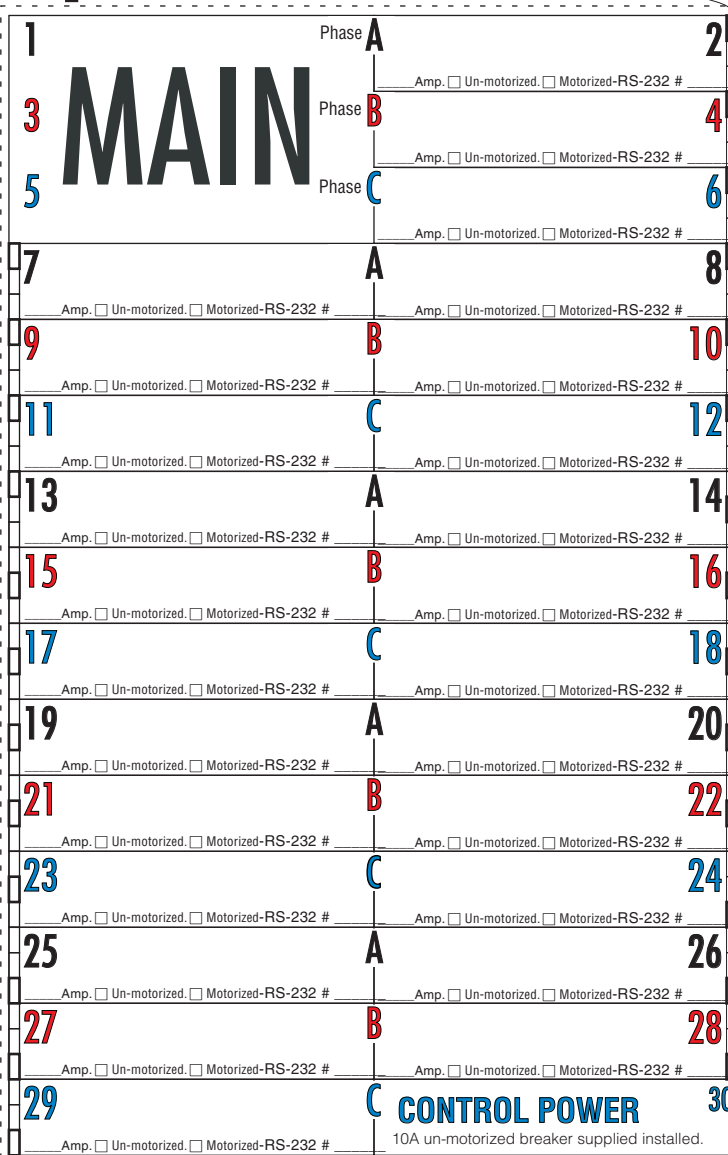

### How it works

The **CONTROL POWER** circuit breaker powers the circuit boards via a 24 volt transformer.

Motorized circuit breakers (face-marked **REMOTELY OPERATED**) are individually actuated by a command from a remote RS-232 control device.

Each numbered LED indicates the status of that addressed breaker.

Lit = ON, Unlit = OFF  
 Flashing = command execution in progress.

Each circuit board controls up to ten 1, 2 or 3 pole motorized circuit breakers.

RS-232 signals are fed to the first board of each RS-232 panel.

Power and RS-232 data are daisy-chain fed board to board by the yellow jumper connectors.

The Board RS-232 address is set for each board by jumpers.

The RS-232 output is an optoisolated, buffered, loop-thru for driving other RS-232 devices. Output data availability is indicated by a flickering LED

### MANUAL CONTROL

The circuit breakers may be manually controlled by the **TEST** switches on each board.

The test switches work in the absence of a RS-232 signal. A valid RS-232 signal, indicated by a flashing **Receiving** RS-232 LED overrides the test switches.

Square D QO327M100 Load Center with LynTec low-voltage sidecar

Standard back-fed Main Breaker QO3100VH. 100A, [VH = 22kAIR].  
 Main options — Part# suffix

**BOLD FACE** = Amps  
 -M3030, -M3035  
 QO3xx [all 10kAIR]

-M3050, -M3060, -3070, or -M3090  
 QO3xxVH [all 22kAIR]  
 [Amps Interrupt Rating]

Wire: #4 - 2/0 kcmil Cu

Outside Dimensions  
 20.9" w., 29.8" h., 3.9" d.  
 Surface mount only.

[www.LynTec.com](http://www.LynTec.com)

800-724-4047

8-5 Central Time

# SC-10 RS232 PROTOCOL

## Commands set

Command	Decimal	Hexadecimal
Start byte	176	0xB0
Stop byte	240	0xF0
Board address	1 - 99	0x01 - 0x63
Output address	1 - 10	0x01 - 0x0A
Output ON	180	0xB4
Output OFF	181	0xB5
Output status	182	0xB6
Status of all outputs	189	0xBD
All ON	186	0xBA
All OFF	187	0xBB
Set/clear output verification status*	190	0xBE

\*Not be implemented - autoscan can distinguish between RR7 and RR9

## 2. Commands description

### 2.1 Outputs ON command

0xB0, board\_address, 0xB4, output\_address\_1, ..., output\_address\_m, 0xF0  
m<=10 (0x0A)

Example: B0 01 B4 04 0A F0, turns on outputs at 4 and 10, on 1st card

### 2.2 Outputs OFF command

0xB0, board\_address, 0xB5, output\_address\_1, ..., output\_address\_n, 0xF0  
n<=10 (0x0A)

Example: B0 02 B5 09 F0, turns off output at 9, on 2nd card

### 2.3 Outputs ON/OFF command

0xB0, board\_address, 0xB4, output\_address\_1, ..., output\_address\_m, 0xB5, output\_address\_1, ..., output\_address\_n, 0xF0  
m and n<=10 (0x0A)

Example: B0 01 B4 04 0A B5 09 F0, turns on output at 4 and 10, and turns off output at 9, on 1st card

### 2.4 Outputs status

0xB0, board\_address, 0xB6, output\_address\_1, ..., output\_address\_m, 0xF0  
m<=10 (0x0A)

Example: B0 03 B6 04 0A F0, status of outputs at 4 and 10, on 3rd card

### 2.5 Status of all outputs

0xB0, board\_address, 0xBD, 0xF0

### 2.6 All ON - turn on all available outputs

0xB0, board\_address, 0xBA, 0xF0

## 2.7 All OFF - turn off all available outputs

0xB0, board\_address, 0xBB, 0xF0

## 2.8 Set/clear output verification status (NOT IMPLEMENTED)

0xB0, board\_address, 0xBE, output\_address\_i, output\_ver\_status\_i, output\_address\_j, output\_ver\_status\_j, ..., output\_address\_n, output\_ver\_status\_n, 0xF0

output\_address\_i, output\_ver\_status\_i, output\_address\_j, output\_ver\_status\_j, ..., output\_address\_n, output\_ver\_status\_n - addresses and status of outputs, n<=10

### Output\_ver\_status coding

Status	Code
Disable	0x01
Enable	0x02

When verification status of the output is disabled, the board will always respond with "no verification" status for this output. Verification status shall be disabled for all outputs driving RR7 relays.

## 3. Responses

### 3.1 Output status codes

Status	Code
Off	0x01
On	0x02
Fault	0x03
No verification, expected off	0x04
No verification, expected on	0x05
Empty	0x06

### 3.2 Output status change response

This response is transmitted when output(s) change(s) status for ANY reason (RS232 command, button push, brown out, recover from brown out, emergency override, recover from emergency override).

0xB0, board\_address, 0xB6, output\_address\_i, output\_status\_i, ..., output\_address\_n, output\_status\_n, 0xF0

n<=10 (0x0A)

Example: B0 01 B6 04 01 05 02 0A 06 F0, output at 4 is off, at 5 is on, and at 10 is empty, on 1st card

### 3.3 Status of all ten outputs (transmitted only in reply to status of all outputs command)

0xB0, board\_address, 0xBD, byte\_1, ..., byte\_10, 0xF0

Example: B0 02 BD 01 01 01 01 01 02 02 02 02 06 F0, outputs 1 thru 5 are off, 6 thru 9 are on, and 10 is empty, on 2nd card

## 4. AMX Device Discovery

Beacon request: "AMX\r"

Beacon: "AMXB<-SDKClass=Utility><-Make=Lyntec><-Model=SC10><-Revision=1.0.0>\r"

# Mechanical Dimensions and Knockouts

**LynTec** MSLC 113-xx, MSLC 127-xx, MSLC 129-xx, MSLC 326-xx, MSLC 329-xx (MLO),  
 LCLC 326-xx, LCLC 329-xx (MLO) SCLC 127-xx, SCLC 129-xx,  
 SCLC 326-xx or SCLC 329-xx (MLO)  
 Surface Mount ONLY

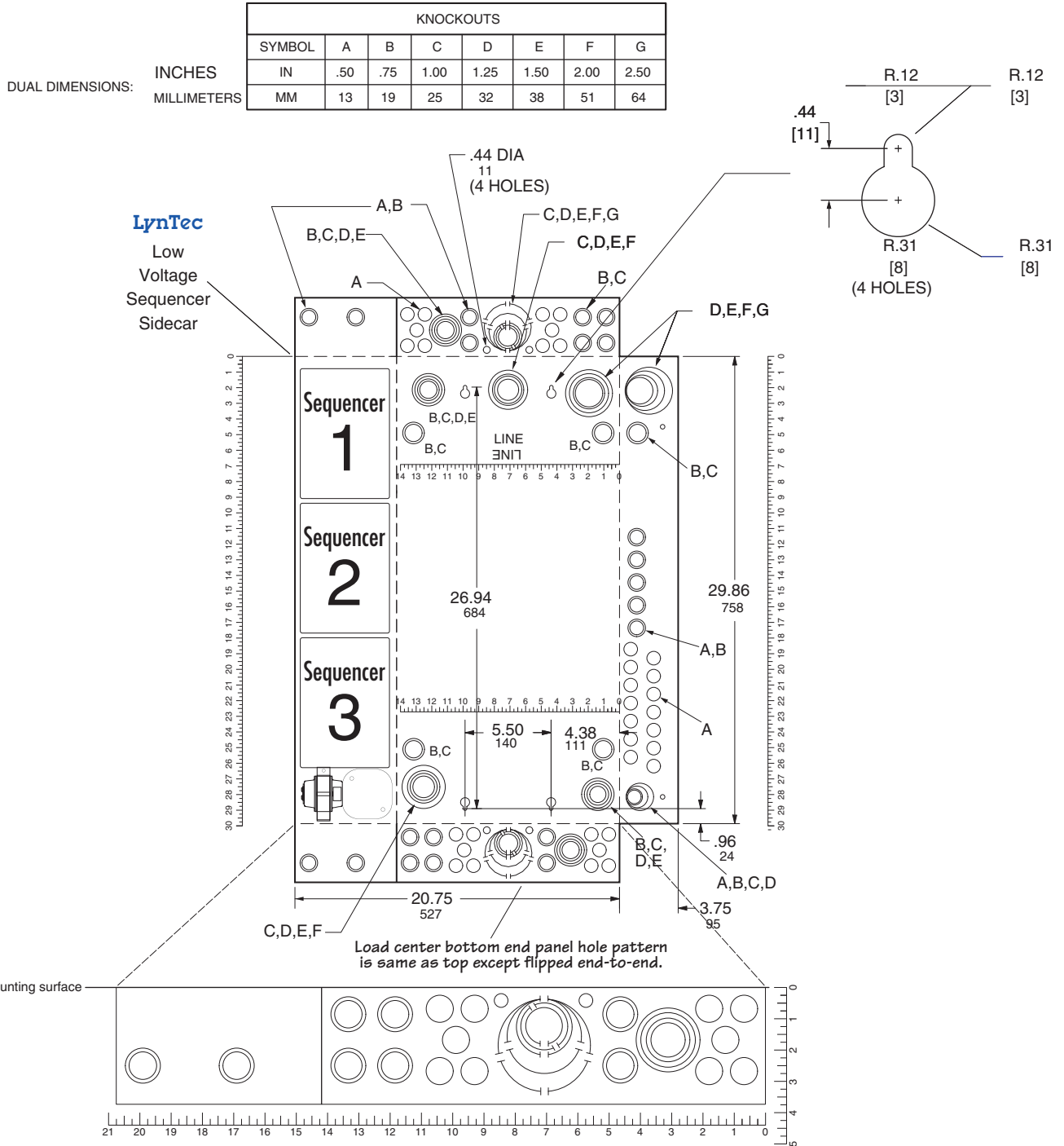

<b>LynTec</b>	SQUARE D CATALOG NUMBER	MAXIMUM SYSTEM VOLTAGE	MAINS AMPERE RATING	SPACES	MAXIMUM NUMBER OF SINGLE POLE CIRCUITS	MAIN WIRE SIZE AWG AL/CU
<b>Single Phase Load Centers</b> EX: MSLC 127 or SCLC 129	QO130M200	120/240Vac 1Ø, 3W	200	30	30	#4-250
<b>Three Phase Load Centers</b> EX: MSLC 326 or LCLC 329	QO327M100	208Y/120Vac 3Ø, 4W	100	27	27	#4-2/0



**QDL & QGL**  
 2 and 3-pole  
 70-250 Amperes

**POWERPACT Q-frame ▲ —250 A, Thermal-magnetic (240 Vac)**

Current Rating @ 40°C	AC Magnetic Trip Settings		D Interrupting	G Interrupting
	Hold	Trip	Catalog Number	Catalog Number
<b>2-pole, 240 Vac</b>				
70	1000	1800	QDL22070	QGL22070 ++
80	1000	1800	QDL22080	QGL22080 ++
90	1000	1800	QDL22090	QGL22090 ++
100	1200	2400	QDL22100	QGL22100 ++
110	1200	2400	QDL22110	QGL22110 ++
125	1200	2400	QDL22125	QGL22125 ++
150	1200	2400	QDL22150	QGL22150 ++
175	1200	2400	QDL22175	QGL22175 ++
200	1200	2400	QDL22200	QGL22200 ++
225	1200	2400	QDL22225	QGL22225 ++
250	1200	2400		

**LynTec**  
**MSP 139**  
**SCP 139**  
 Use a 2 pole, back-fed main breaker, rated at 100 AMPS or less.

**LynTec**  
**MSP 119, MSP 141**  
**SCP 141**  
 ++ All models  
 70-225A  
 Special order. NCNR  
 Non Cancelable  
 Non Returnable

Current Rating @ 40°C	AC Magnetic Trip Settings		D Interrupting	G Interrupting
	Hold	Trip	Catalog Number	Catalog Number
<b>3-pole, 240 Vac</b>				
70	1000	1800		QGL32070
80	1000	1800		QGL32080
90	1000	1800		QGL32090
100	1200	2400		QGL32100
110	1200	2400		QGL32110
125	1200	2400		QGL32125
150	1200	2400	QDL32150 +	QGL32150
175	1200	2400	QDL32175	QGL32175
200	1200	2400	QDL32200 +	QGL32200
225	1200	2400	QDL32225	QGL32225
250	1200	2400		

**LynTec**  
**LCLC 326**  
**MSLC 326**  
**MSLC 338**  
**MSP 338**  
**SCLC 326**  
**SCLC 338**  
**SCP338**  
 Use a 3 pole, back-fed main breaker, rated at 100 AMPS or less.  
 QO3xxxVH Series

**LynTec**  
**LCLC 341**  
**MSLC 341**  
**SCLC 341**  
 Standard  
 + Optional from stock

▲ Replacement lugs are not available for POWERPACT Q-frame circuit breakers. Lugs for the POWERPACT Q-frame circuit breakers accept (1) #4-300 kcmil.

**Interrupting Ratings (kA)**

	QD	QG
240 V	25	65

For **Branch Breaker Series Ratings**  
 see [http://www.lyntec.com/139-0407\\_Series\\_Ratings.pdf](http://www.lyntec.com/139-0407_Series_Ratings.pdf)

Accessories ..... pages 6-36-6-38  
 Optional Lugs ..... pages 6-43, 6-44  
 Dimensions ..... pages 6-49, 6-50  
 Enclosures ..... pages 6-51-6-54

# Series Ratings

For NQOD and NF Panelboards  
Class 1630, 1670

This page contains UL Tested and Certified series combination ratings for panelboards. These ratings apply to either an integral main located in the same enclosure or a remote main located in a separate enclosure.

## NQOD Series Ratings

Maximum System Voltage AC <sup>c</sup>	Maximum Short Circuit Current Rating (RMS Symmetrical)	Integral or Remote Main Circuit Breakers and Remote Main Fuses	Branch Circuit Breaker Designations and Allowable Ampere Ranges <sup>ab</sup>			
			Type	1-pole	2-pole	3-pole
120/240 1Ø	22k	MG	QO (B)	15-30 A	...	...
	42k	HD, JD	QO (B) PL	15-30 A	15-60 A	15-30 A
	65k	HG, JG	QO (B) PL	15-30 A	15-60 A	15-30 A
	100k	HJ, JJ	QO (B) PL	15-30 A	15-60 A	15-30 A
	125k	HL, JL	QO (B) PL	15-30 A	15-60 A	15-30 A
120/240 1Ø 208Y/120	100k	DJ 400 A	QO (B) QO (B) GFI QO (B) VH QO (B) PL QO (B) AFI	15-70 A 15-30 A ... 15-30 A 15-20 A	15-125 A 40-60 A 150 A ...	... 15-150 A ...
		QJ	QO (B) QO (B) AS QO (B) GFI QO (B) PL QO (B) VH QO (B) AFI	15-70 A 15-30 A 15-30 A 15-30 A 15-30 A 15-20 A	15-125 A 15-30 A 15-60 A 15-60 A 150 A ...	15-30 A 15-30 A 15-30 A 15-30 A 35-150 A ...
	18k	LA/LH (L) 34200MC LA/LH (L) 34225MC LA/LH (L) 34250MC LA/LH (L) 34400MC	QO (B)	15-30 A	15-30 A	15-30 A
			QO (B) VH	15-70 A 15-30 A 15-30 A 15-30 A 15-20 A	15-125 A 15-30 A 15-60 A 15-30 A ...	15-100 A 15-30 A ...
	22k	Q2-Hf	QO (B)	15-70 A 15-30 A 15-20 A	15-100 A 15-30 A ...	15-30 A ...
			QO (B) GFI QO (B) AFI	15-70 A 15-30 A 15-20 A	15-125 A 15-30 A ...	15-30 A ...
	25k	ED, FDF	QO (B)	15-70 A 15-30 A 15-20 A	15-125 A 15-60 A ...	15-100 A ...
			QO (B) GFI QO (B) AFI	15-70 A 15-30 A 15-20 A	15-125 A 15-30 A ...	15-100 A ...
	25k	KDF	QO (B)	15-70 A 15-30 A 15-30 A 15-20 A	15-125 A 15-60 A 15-60 A ...	15-100 A 15-30 A ...
			QO (B) AS QO (B) GFI QO (B) AFI	15-70 A 15-30 A 15-30 A 15-20 A	15-125 A 15-30 A 15-60 A ...	15-100 A 15-30 A ...
25k	HD, JD	QO (B)	15-70 A 15-30 A 15-30 A 15-20 A	15-125 A 15-60 A 15-60 A ...	15-100 A 35-150 A ...	
		QO (B) VH QO (B) GFI QO (B) PL QO (B) AFI QO (B) H QO (B) VH QO (B) AFI	15-70 A 15-30 A 15-30 A 15-20 A ... 15-100 A 150 A ...	15-125 A 15-30 A 15-60 A 15-60 A 150 A ...	15-100 A 35-150 A ...	
42k	LA, MA	Q2L-Hf	...	110-225 A 70-225 A	110-225 A 70-225 A	
		QDL	...	110-225 A 70-225 A	110-225 A 70-225 A	
42k	MG	QO (B) VH	15-30 A	15-30 A	15-30 A	
		QO (B) PL	15-30 A	15-60 A	15-30 A	
42k	LC 600 A Maximum	QO (B)	15-70 Ad 15-30 A	...	...	
		QO (B) VH	15-70 Ad 15-30 A	15-125 A 15-60 A	15-100 A (3P 208 V Max.) ...	
65k	QO (B) GFI QO (B) AFI	15-30 Ae 15-20 A	15-60 A ...	...	...	
		QO (B) VH	15-30 A 15-20 A	15-125 A ...	15-100 A (3P 208 V Max.) ...	
65k	DJ 400 A	QO (B)	15-70 A 15-30 A 15-20 A	15-125 A 150 A 15-100 A	15-150 A ...	
		QO (B) VH QO (B) H	15-70 A 15-30 A 15-20 A	15-125 A 150 A 15-100 A	15-150 A ...	
65k	EG, FGf, KGf	QO (B)	15-70 A 15-30 A 15-20 A	15-125 A 15-60 A ...	15-100 A ...	
		QO (B) GFI QO (B) AFI	15-70 A 15-30 A 15-20 A	15-125 A 15-60 A ...	15-100 A ...	
65k	QG, HG, JG	QO (B)	15-70 A 15-30 A 15-20 A	15-125 A 15-60 A 15-60 A	15-30 A 15-30 A 15-30 A	
		QO (B) AS QO (B) VH	15-70 A 15-30 A 15-20 A	15-125 A 15-60 A ...	15-30 A 15-30 A 35-150 A	
65k	HG, JG	QO (B)	15-70 A 15-30 A 15-20 A	15-125 A 150 A 150 A	15-100 A 35-150 A ...	
		QO (B) VH QO (B) H QO (B) VH QO (B) AFI	15-70 A 15-30 A 15-30 A 15-20 A	15-125 A 150 A 150 A ...	15-100 A 35-150 A ...	
65k	FCL22 KCL22 FCL32 KCL32	QO (B)	15-70 A 15-30 A 15-30 A 15-20 A	15-100 A 15-30 A 15-30 A ...	15-100 A 15-30 A ...	
		QO (B) AS QO (B) GFI QO (B) AFI	15-70 A 15-30 A 15-30 A 15-20 A	15-100 A 15-30 A 15-30 A ...	15-100 A 15-30 A ...	
65k	400 A Max. Class J or T6 Fuses	QO (B) VH	15-30 A 15-20 A	15-125 A 150 A	15-100 A ...	
		QO (B) AFI	15-30 A 15-20 A	15-125 A 150 A	15-100 A ...	
100k	FCL24 KCL24 FCL34 KCL34	QO (B)	15-70 A 15-30 A 15-30 A 15-20 A	15-100 A 15-30 A 15-30 A ...	15-100 A 15-30 A ...	
		QO (B) AS QO (B) GFI QO (B) AFI	15-70 A 15-30 A 15-30 A 15-20 A	15-100 A 15-30 A 15-30 A ...	15-100 A 15-30 A ...	
100k	200 A Max. Class T3 Fuses	QO (B) AFI	15-20 A	...	...	
100k	EJ, FJf	QO (B)	15-70 A 15-30 A 15-20 A	15-125 A 15-60 A ...	15-100 A ...	

LynTec models  
LCLC 326  
MSLC 326  
SCLC 326  
MSLC 338  
SCLC 338  
MSP 338  
SCP 338  
MSP139

LynTec models  
LCLC 341  
MSLC 341  
SCLC 341

LynTec models  
MSLC 113  
MSLC 127  
MSLC 129  
are series rated 22k AIR.  
see QO130Mxx on pg 1-3 of Digest

8 PANELBOARDS

LynTec models  
MSP 119  
MSP 141  
SCP 141  
LCP 341  
MSP 341  
SCP 341

**QOxxx (B) = BUMB series Bolt-on, UnMotorized Breaker**  
-xxx = poles. xxx = trip current.  
[1 pole] BUMB-15, BUMB-20, BUMB-30  
[2 pole] BUMB-215, BUMB-220, BUMB-230  
[3 pole] BUMB-315, BUMB-320, BUMB-330  
**QOxxx = UMB series clip-on, UnMotorized Breaker**  
-xxx = poles. xxx = trip current.  
[1 pole] UMB-15, UMB-20, UMB-30  
[2 pole] UMB-215, UMB-220, UMB-230  
[3 pole] UMB-315, UMB-320, UMB-330  
All 15 & 20 A breakers are HM (High Magnetic)

## NQOD Series Ratings (Continued)

Maximum System Voltage AC <sup>c</sup>	Maximum Short Circuit Current Rating (RMS Symmetrical)	Integral or Remote Main Circuit Breakers and Remote Main Fuses	Branch Circuit Breaker Designations and Allowable Ampere Ranges <sup>ab</sup>			
			Type	1-pole	2-pole	3-pole
240	100k	HJ, JJ	QO (B)	15-70 A	15-125 A	15-100 A
			QO (B) VH QO (B) GFI QO (B) PL QO (B) AFI	15-70 A 15-30 A 15-30 A 15-20 A	15-125 A 15-60 A 15-60 A ...	15-100 A 35-150 A 15-30 A ...
	125k	HL, JL	QO (B) H	15-70 A	15-125 A	15-100 A
			QO (B) VH QO (B) AFI	15-70 A 15-30 A	15-125 A 150 A	15-100 A 15-30 A
200k	FI, KI	QO (B)	15-70 A	15-125 A	15-100 A	
200k	Maximum Fuses 200 A Class J or T6 400 A Class T3	QO (B) AS QO (B) GFI	15-70 A 15-30 A	15-125 A 15-60 A	15-100 A 15-30 A	

- ▲ Suffixes HID, SWD and SWN may also be applied to the applicable branch circuit breakers shown above, except suffix SWN may NOT be applied in combination with LC main circuit breakers.
  - Where QO (B) circuit breakers are shown above, QO (B) H, QO (B) VH, and QH (B) circuit breakers may also be used.
  - For shown circuit breakers rated less than this maximum voltage, the indicated short circuit current rating also applies, but at the voltage rating of the circuit breaker.
  - ★ Only 15-30 A circuit breakers may be used when the LC circuit breaker is rated 450, 500 or 600 A.
  - ▼ Circuit breakers may not be used when the LC circuit breaker is rated 450, 500 or 600 A.
  - △ Obsolete. Contact your nearest Square D/Schneider Electric sales office for replacement circuit breaker. One-pole FJ circuit breakers are still available.
- Where QO(B) GFI circuit breakers are shown above, QO(B), EPD circuit breakers may also be used.

## NF Series Ratings

Maximum System Voltage AC	Maximum Short Circuit Current Rating (RMS Symmetrical)	Main Type	Branch Type	Poles
240	65,000	EG, FH, FGf, KH, LH, MH, MX, HG, JG	EDB, EDB-EPD	1, 2 & 3
		EG	ECB-G3	
	100,000	EJ, FC, FJf, KC, LC, LX, HJ, JJ	EDB, EDB-EPD, EGB	1, 2 & 3
		EJ, FC, KC, HJ, JJ	ECB-G3	
	125,000	HL, JL	EDB, EDB-EPD, EGB, ECB-G3	1, 2 & 3
		FI, KI, LI, LXI	ECB-G3	
200,000	FI, KI	EDB, EDB-EPD, EGB, EJB	1, 2 & 3	
	FI, KI	ECB-G3		
480Y/277	35,000	EG, FGf, KH, LH, HG, JG	EDB, EDB-EPD	1, 2 & 3
		EG, HG, JG	ECB-G3	
	65,000	EJ, FC, FJf, KC, LC, LX, HJ, JJ	EDB, EDB-EPD, EGB	1, 2 & 3
		EJ, FC, KC, HJ, JJ	ECB-G3	
	100,000	HL, JL	EDB, EDB-EPD, EGB	1, 2 & 3
		FI, KI, LI, LXI	ECB-G3	
200,000	FI, KI	EDB, EDB-EPD, EGB, EJB	1, 2 & 3	
	FI, KI	ECB-G3		
600Y/347	18,000	HG, JG, MG	EDB, EDB-EPD	1, 2, 3
		EJ, FI, KH, KL, LC, LE, LX, LI, LXI, HJ, JJ	EDB, EDB-EPD, EGB	
	25,000	LH	EDB(15-70 A), EGB	1, 2, 3
		LC, LE	EDB, EDB-EPD, EGB, EJB	
	35,000	HL, JL	EDB, EDB-EPD, EGB	1, 2, 3
		FI, KI	EDB, EDB-EPD, EGB, EJB	
65,000	LI, XI	EJB	1, 2 & 3	
	Remote Main Fuse			
240	200,000	200 Ampere Maximum Class J or T (600V)	ECB-G3	1, 2 & 3
480Y/277	100,000	400 Ampere Maximum Class J or T (600V)	EDB, EDB-EPD, EGB, EJB	1, 2 & 3
		200 Ampere Maximum Class J or T (600V)	EDB, EDB-EPD, EGB, EJB	
	200,000	200 Ampere Maximum Class J or T (600V)	ECB-G3	
600Y/347	200,000	200 Ampere Maximum Class J or T (600V)	EDB, EDB-EPD, EGB, EJB	1, 2 & 3

**QOPLxxx-5393 = BMB series Bolt-on, Motorized. (REMOTELY OPERATED)**  
-xxx = poles. xxx = trip current. -5393 suffix denotes special 60" control wires.

[1 pole] BMB-15, BMB-20, BMB-30  
[2 pole] BMB-215, BMB-220, BMB-230, BMB-240, BMB-250, BMB-260  
[3 pole] BMB-315, BMB-320, BMB-330

**QOPLxxx-5393 = MB series clip-on, Motorized. (REMOTELY OPERATED)**  
-xxx = poles. xxx = trip current. -5393 suffix denotes special 60" control wires.

[1 pole] MB-15, MB-20, MB-30  
[2 pole] MB-215, MB-220, MB-230, MB-240, MB-250, MB-260  
[3 pole] MB-315, MB-320, MB-330

# Instruction Bulletin

## QO-PL (Plug-on), QOB-PL (Bolt-on) Powerlink<sup>®</sup> Remotely Operated Circuit Breakers

(Use in Type QO Load Centers and Type NQO, NQOB, and NQOD Panelboards)

Retain for future use.

### REQUIREMENTS

#### Remotely Operated Circuit Requirements

#### **⚠ DANGER**

##### HAZARD OF ELECTRIC SHOCK, BURN, OR EXPLOSION.

When servicing a branch circuit fed by a remotely operated circuit breaker, move handle of remotely operated circuit breaker to OFF position. Do not rely on remote operation to open circuit breaker.

**Failure to follow these instructions will result in personal injury or death.**

### CIRCUIT BREAKER INSTALLATION

#### **⚠ DANGER**

##### HAZARD OF ELECTRIC SHOCK, EXPLOSION, OR ARC FLASH

- Apply appropriate personal protective equipment (PPE) and follow safe electrical work practices. See NFPA 70E.
- This equipment must be installed and serviced only by qualified electrical personnel.
- Turn off all power supplying this equipment before working on or inside equipment.
- Always use a properly rated voltage sensing device to confirm power is off.
- Replace all devices, doors, and covers before turning on power to this equipment.

**Failure to follow these instructions will result in death, or serious injury.**

See page 2 for  
**LynTec**  
part number explanation

POWERLINK<sup>®</sup> QO(B)-PL Remotely Operated Circuit Breakers require a power supply capable of delivering at least two amperes at 24 Vdc for a minimum of 50 milliseconds. One-, two-, and three-pole circuit breakers all have one internal motor, and power requirements are the same regardless of the number of poles and ampere ratings.

The required power supply ampacity and control device contact rating are determined by the number of circuit breakers to be switched simultaneously (i.e., four circuit breakers switched simultaneously require a power supply and a control device contact rated 8 amperes minimum). The control device may be either a normally-open (NO)/normally-closed (NC) contact; a single-pole, double-throw switch (SPDT); or other three-wire control device.

1. Turn off all power supplying this equipment before working on or inside equipment.
2. Before installing circuit breaker turn circuit breaker handle to OFF position.
3. Remove panelboard cover and deadfront. Verify power is off with voltage meter before proceeding.

**Installation of circuit breaker into panelboard/load center (refer to figure below)**

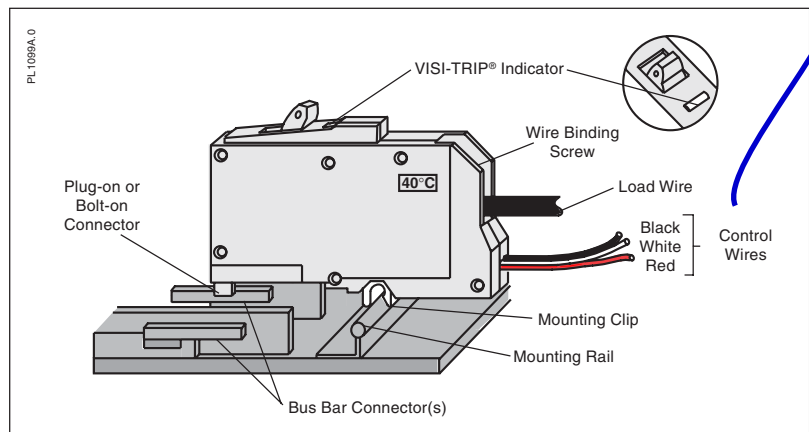

4. Except for remotely operated connections, QO(B)-PL remotely operated circuit breakers are installed in a panelboard/load center the same as conventional QO(B) circuit breakers.

**Connection of remotely operated circuit (refer to the figure on next page)**

5. Assure that power supply and control device meet requirements listed under "Remotely Operated Circuit Requirements."

All LynTec supplied breakers have special 60" control wires. (Square D standards are 18".)



**CIRCUIT BREAKER INSTALLATION**

**CAUTION**

**HAZARD OF CIRCUIT BREAKER DAMAGE.**

Connect the 24 Vdc remote control wiring as shown on this page.

**Failure to follow these instructions can permanently damage the remotely operated circuit breaker.**

**LynTec**  
 part numbers

**MB series motorized circuit breakers (Snap-On)**  
 May be used in LCLC, LCP, MSLC, MSP, SLC or SP series panels.

**BMB series motorized circuit breakers (Bolt-On)**  
 Use only in LCP, MSP or SP Panelboards

All **BMB** & **MB** series breakers have Square D part number suffix of -5393 indicating a special 60 inch lead length for remote control wires required to connect to LynTec control boards in low voltage cabinet.

\*\* = Stocked items

\*\***MB-15** = 15 Amp. Square D QO-115PL-5393

\*\***BMB-15** = 15 Amp. Square D QOB-115PL-5393

\*\***MB-20** = 20 Amp. Square D QO-120PL-5393

\*\***BMB-20** = 20 Amp. Square D QOB-120PL-5393

\*\***MB-30** = 30 Amp. Square D QO-130PL-5393

\*\***BMB-30** = 30 Amp. Square D QOB-130PL-5393

Two pole motorized - call for pricing & delivery

**MB-215** = 15 Amp. Square D QO-215PL-5393

**BMB-215** = 15 Amp. Square D QOB-215PL-5393

\*\***MB-220** = 20 Amp. Square D QO-220PL-5393

\*\***BMB-220** = 20 Amp. Square D QOB-220PL-5393

**MB-230** = 30 Amp. Square D QO-230PL-5393

**BMB-230** = 30 Amp. Square D QOB-230PL-5393

40A, 50A or 60A, Two pole also available on Special Order

Three pole motorized - call for pricing & delivery

**MB-315** = 15 Amp. Square D QO-315PL-5393

**BMB-315** = 15 Amp. Square D QOB-315PL-5393

**MB-320** = 20 Amp. Square D QO-320PL-5393

**BMB-320** = 20 Amp. Square D QOB-320PL-5393

**MB-330** = 30 Amp. Square D QO-330PL-5393

**BMB-330** = 30 Amp. Square D QOB-330PL-5393

LynTec also stocks **UMB** & **BUMB** (un-motorized) QO series circuit breakers including HM (High Magnetic). Recommended for eliminating nuisance trips in high inrush applications. [All BMB & MB-x15's and BMB & MB-x20's are HM breakers.]

**800-724-4047**

LynTec ■ www.LynTec.com

8401 Melrose Dr., Lenexa, KS 66214, USA

Voice 913-529-2233 • Fax 888-722-4157 or 913-529-4157

LynTec overprint 139-0216-08.2 9/23/06

- All wiring and splicing must comply with applicable code requirements for Class 1 circuits. Refer to paragraph 373-8 and article 725 of the National Electrical Code.
- Three #18 AWG control wires are attached to the remotely operated circuit breaker for connection to the power supply and remote control device and should be cut to the required length to reach the splice connections. Use #18 AWG or larger conductors with 600 V insulation and approved wire connectors for splices.
- Connect the black lead of the remotely operated circuit breaker to the negative (-) terminal of the 24 Vdc power supply. Connect the red lead of the remotely operated circuit breaker to the positive (+) terminal of the 24 Vdc power supply. Connect the white lead of the remote control device. The remote control device provides connections between either positive or negative potential of the power supply and the white wire of the remotely operated circuit breaker, as appropriate.
- Applying the positive potential of the power supply to the white wire (contact closure between the red wire and white wire) will operate the remote mechanism of the circuit breaker to the OFF position. Applying the negative potential of the power supply to the white wire (contact closure between the black wire and the white wire) will operate the remote mechanism of the circuit breaker to the ON position. A control circuit utilizing a normally open (NO)/normally closed (NC) contact is illustrated below.

*NOTE: The remote mechanism will not move the circuit breaker handle. Also, the remote mechanism cannot turn power ON when the circuit breaker is tripped (VISI-TRIP® flag indicator showing) or when the circuit breaker handle is in the OFF position.*

**Installation of the trim and operational checks**

- Remove corresponding twist-out from panelboard trim and replace trim.
- Turn power to panelboard on.
- Turn remotely operated circuit breaker handle to the ON position.
- Turn power to the remotely operated circuit on and test this circuit, turning remotely operated circuit breaker off remotely, then on remotely. If power to remote controlled circuit breaker load does not switch off and on, turn off power to remotely operated circuit and panelboard and check wiring.

*NOTE: A power supply is available from Square D Company, Cat. No. QOPLPS (plug-on) or QOBPLPS (bolt-on).*

**Splice not normally required with LynTec supplied breakers with 60" leads.**

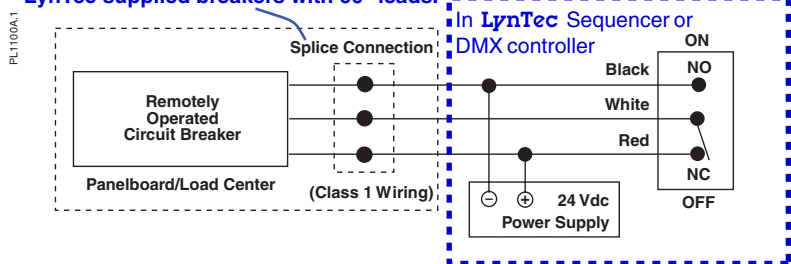

Electrical equipment should be installed, operated, serviced and maintained only by qualified personnel. No responsibility is assumed by Schneider Electric for any consequences arising out of the use of this material.

© 1991-2003 Schneider Electric All Rights Reserved

Square D Company  
 3700 Sixth Street SW  
 Cedar Rapids IA 52404 USA  
 1-888-SquareD (1-888-778-2733)  
 www.SquareD.com

